

Diesel PCM Outputs

Injector Driver Module

The Injector Driver Module controls power to the fuel injectors based on information received from the PCM. The Injector Driver Module receives two digital control signals from the PCM: the Fuel Delivery Control Signal and the Camshaft Position signal. The Fuel Delivery Control Signal is used by the Injector Driver Module to control injection timing and injection duration. The CMP signal provides synchronization to the engine's first and the fifth injector (firing order, cylinders number one and four). The Injector Driver Module verifies that Fuel Delivery Control Signal and CMP occur at valid timing intervals for synchronization.

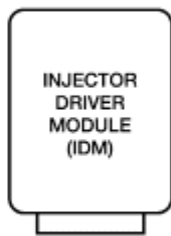

DA2194-A

Exhaust Back Pressure Regulator

Note: The Exhaust Back Pressure Regulator is not present on F650/750 models.

Exhaust back pressure is controlled to provide more heat to the coolant for cab heating when ambient air temperature is below 7°C (45°F) and engine oil temperature is below 75°C (167°F) during low load. At high load, high speed conditions, the back pressure system is disabled.

The exhaust back pressure regulator solenoid and exhaust back pressure piston are contained in the turbocharger mounting pedestal. Turbocharger pressurized lube oil is routed to the exhaust back pressure solenoid. Oil regulated by the exhaust back pressure solenoid actuates the piston which operates the back pressure valve in the exhaust housing.

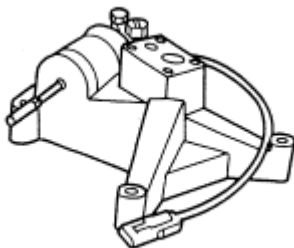

AA0835-A

Allison Automatic Transmission Downshift Solenoid (F650/750)

The PCM controls a relay which provides the kickdown necessary for wide open throttle (WOT) downshifts. The relay is powered through a circuit from KEY_ PWR and switches VBATT through FUSE PDB #10 (MINI 15A) to the (+) positive side

of the transmission mounted solenoid.

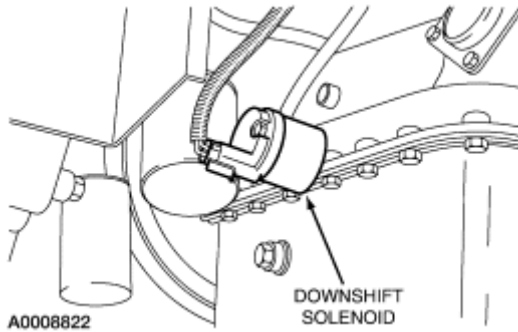

Injection Pressure Regulator

The Injection Pressure Regulator controls injection oil pressure. An electrical signal to a solenoid creates a magnetic field which applies a variable force on a valve servo to control pressure. The quantity of fuel delivered to the combustion chamber is proportional to injection control pressure.

An open circuit will result in minimum oil pressure and a no-start situation. A short circuit results in maximum oil pressure, and is limited by a mechanical pop-off valve to 27,580 kPa (4000 psi).

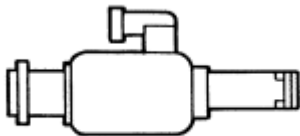

AA0836-A

Tachometer Output

The Tachometer Output provides a signal from the PCM to the instrumentation system. The signal is a buffered representation of the Camshaft Position Sensor (CMP). The tachometer is part of the instrument cluster.

An open or short circuit of the tachometer output wiring will result in an inoperative tachometer.



AA0837-A

Glow Plug Relay Control

The Glow Plug (GP) Relay Control is used to energize the glow plugs for assisting cold engine start-up. Engine Oil Temperature, battery positive voltage (B+), and Barometric Pressure (BARO) are used by the PCM to calculate glow plug on-time and the length of the duty cycle. On-time normally varies between 1 and 120 seconds. With colder oil temperatures and lower barometric pressures, the plugs are on longer. If battery voltage is abnormally high, the duty cycle is shortened to extend plug life. (The glow plug relay will only cycle on and off repeatedly when there is a system high voltage condition

greater than 16 volts.)

An open in the glow plug relay circuit will render the glow plugs inoperative. A short circuit will result in a glow plug's always ON condition.

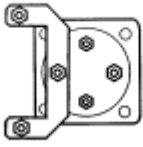

AA0838-A

Glow Plug Light Signal

The Glow Plug (GP) light signal controls the WAIT TO START indicator light located on the instrument panel. When the light goes off, the engine is ready to be started. As a bulb check, the light comes on every time a key on reset occurs, even though the glow plug system is not commanded on. On-time normally varies between 1 and 10 seconds. WAIT TO START light on-time is independent of glow plug relay on-time because the glow plugs may stay on to improve performance until engine reaches operating temperature.

An open circuit in the glow plug light wiring will result in an inoperative glow plug light. A short circuit will result in a glow plug light always ON condition.

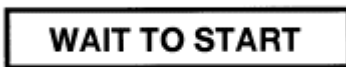

AA0839-A

Manifold Intake Air Heater (MIAH)

Note: The Manifold Intake Air Heater is not used on the F650/750.

To reduce white smoke during long idle periods at low ambient temperatures, the PCM will activate the intake air heater. Specific conditions must be present before the heater is activated:

- ambient temperature must be below 0°C (32°F)
- engine oil temperature (EOT) must be below 55°C (131°F)
- vehicle power (IVPWR) must be between 11.8 and 15.0 volts
- parking brake must be applied on manual transmission vehicles
- the transmission must be in Park or Neutral on automatic transmission vehicles
- glow plugs must be off

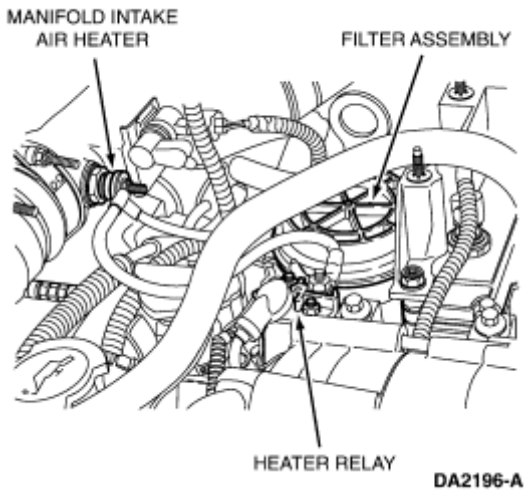

Electronic Passive Anti-Theft System

The Excursion is equipped with an electronic passive anti-theft system (EPATS) which prevents engine operation without the properly encoded ignition key. For detailed information on the operation of this system, refer to Section 419-01 in the Workshop Manual.
