

# 13-1 POWER DISTRIBUTION

2000 EXCURSION, SUPER DUTY SERIES F-250, F-350, F-450, F-550

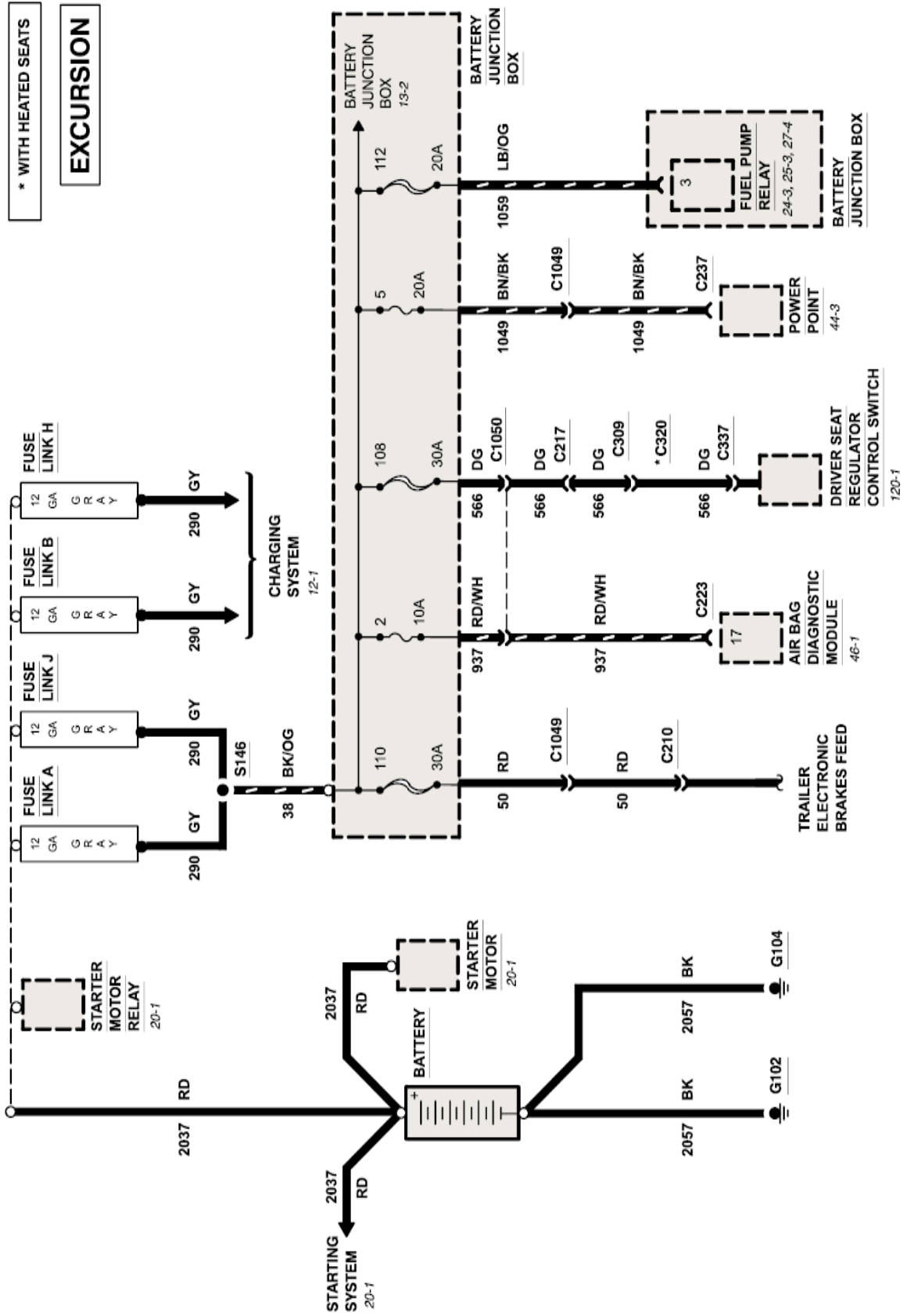

# POWER DISTRIBUTION 13-2

2000 EXCURSION, SUPER DUTY SERIES F-250, F-350, F-450, F-550

## EXCURSION

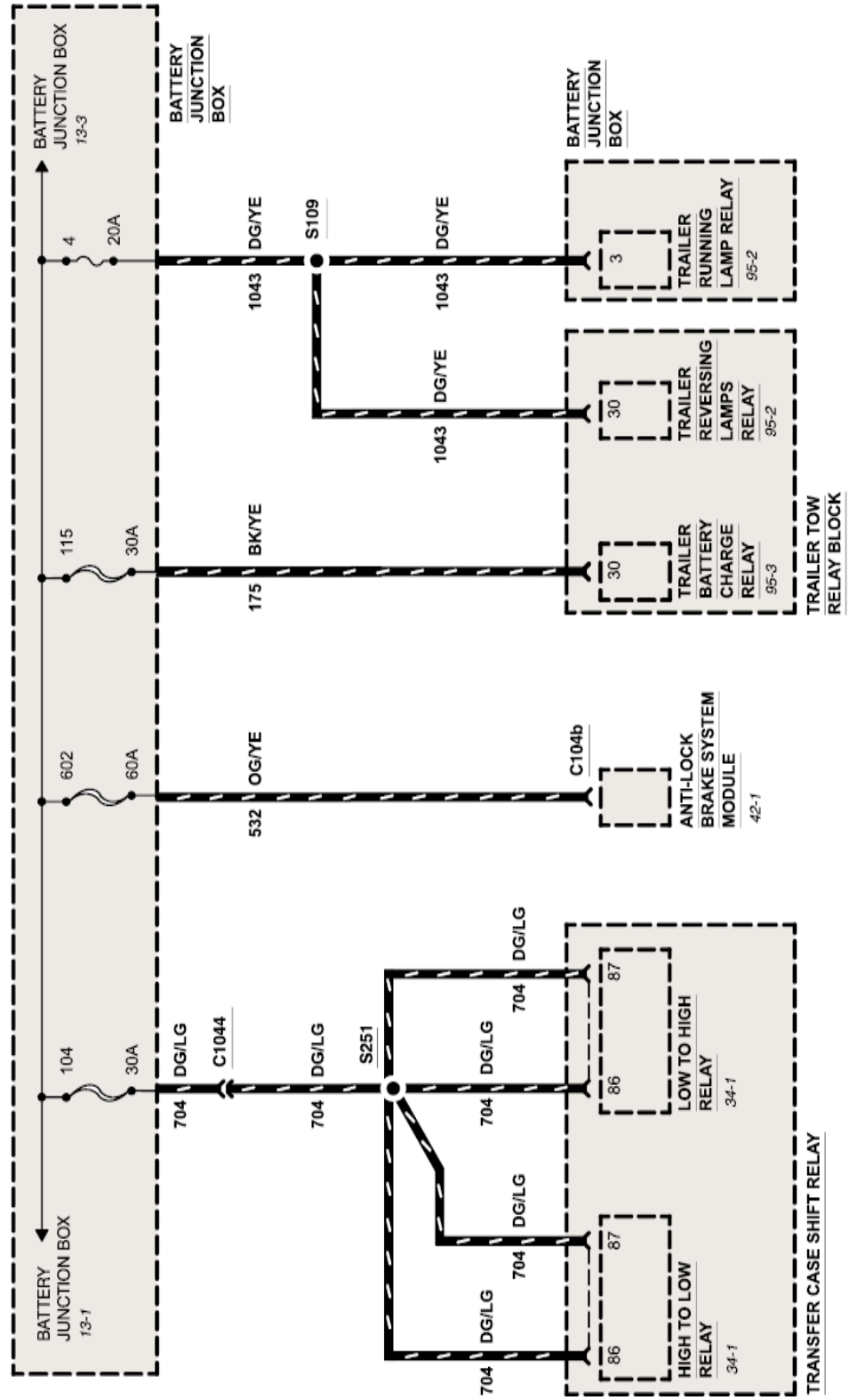

# 13-3 POWER DISTRIBUTION

2000 EXCURSION, SUPER DUTY SERIES F-250, F-350, F-450, F-550

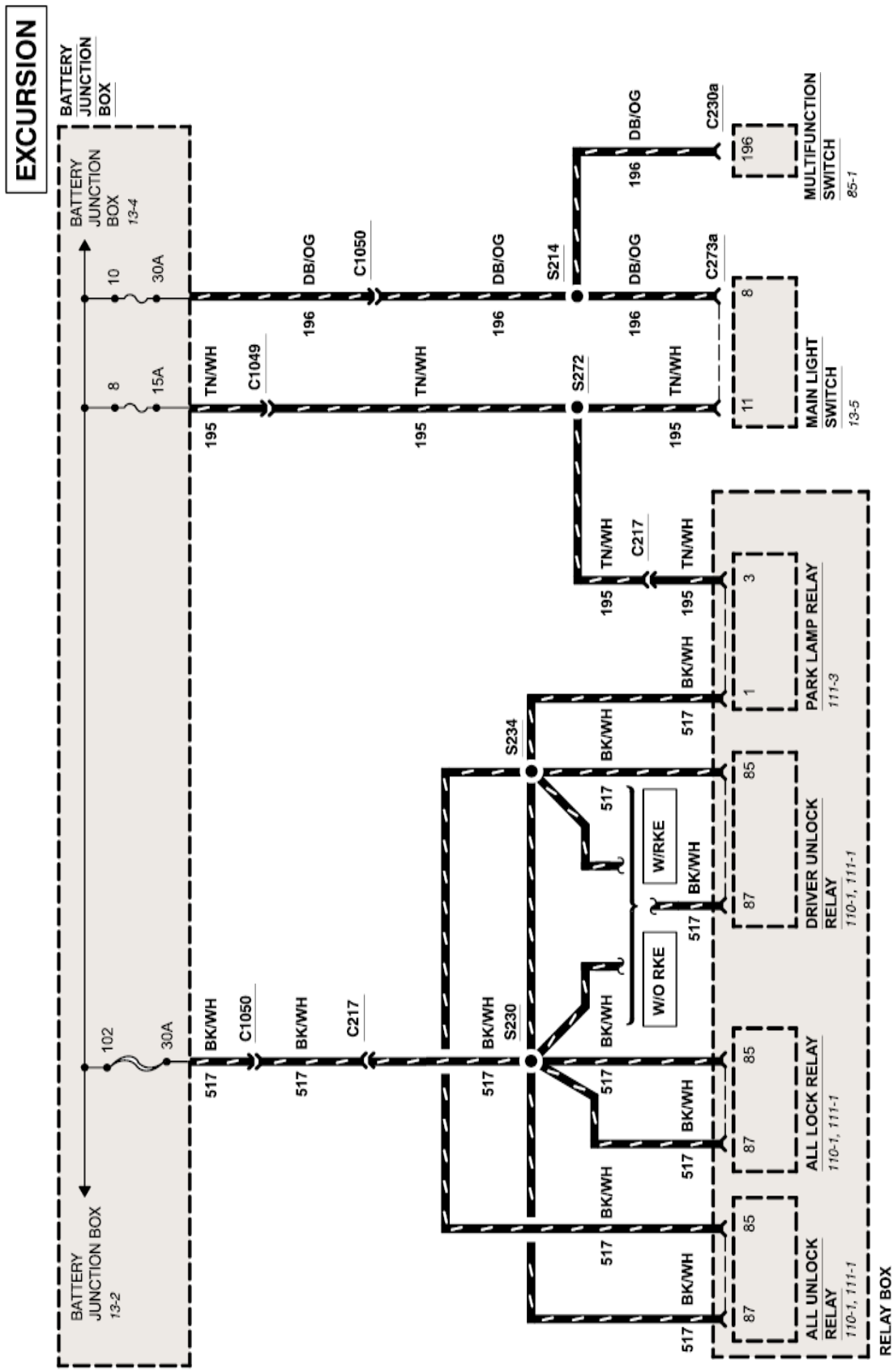

# POWER DISTRIBUTION 13-4

2000 EXCURSION, SUPER DUTY SERIES F-250, F-350, F-450, F-550

## EXCURSION

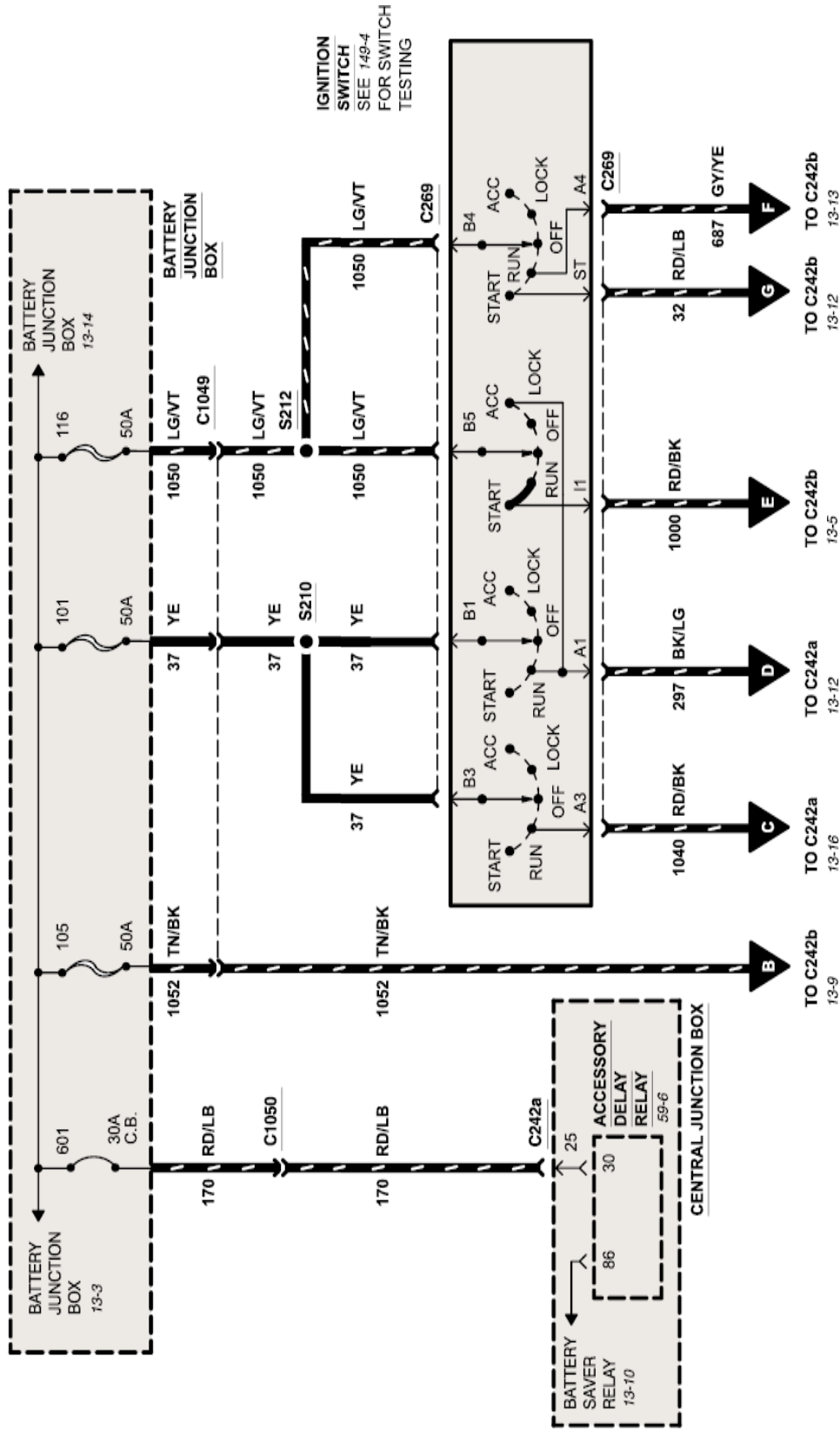

# 13-5 POWER DISTRIBUTION

2000 EXCURSION, SUPER DUTY SERIES F-250, F-350, F-450, F-550

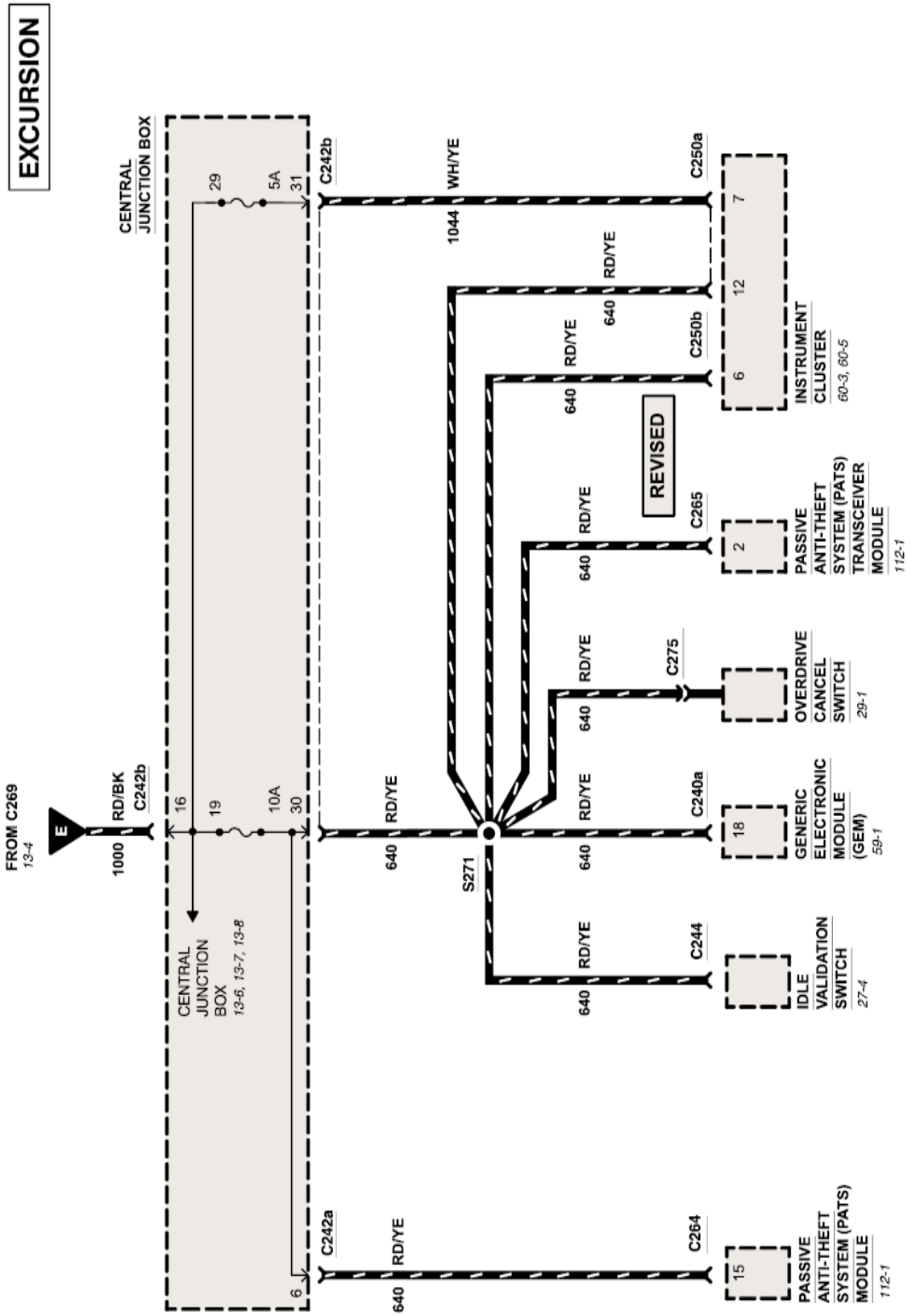

# POWER DISTRIBUTION 13-6

2000 EXCURSION, SUPER DUTY SERIES F-250, F-350, F-450, F-550

**DIESEL**

**EXCURSION**

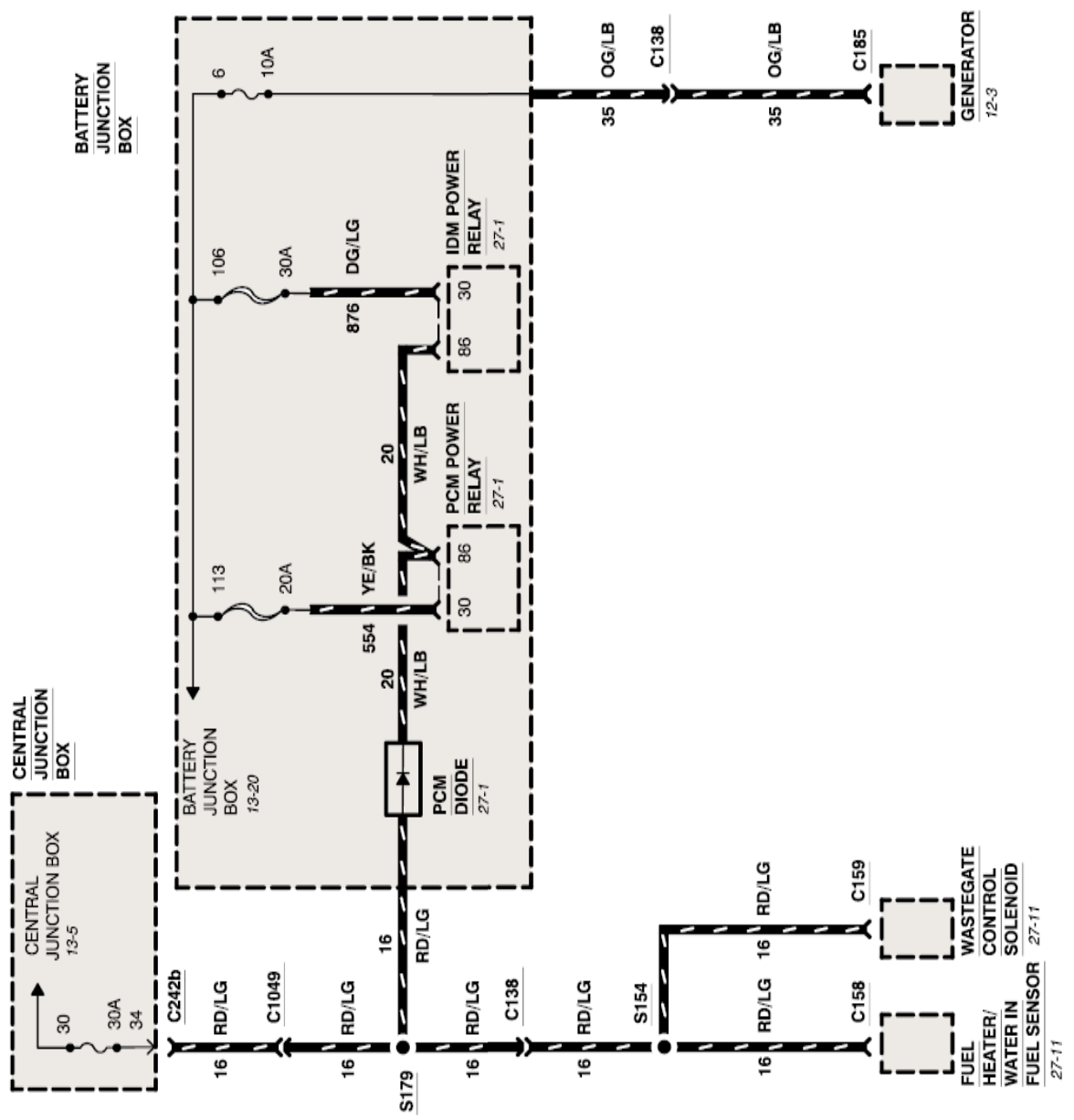

# 13-7 POWER DISTRIBUTION

2000 EXCURSION, SUPER DUTY SERIES F-250, F-350, F-450, F-550

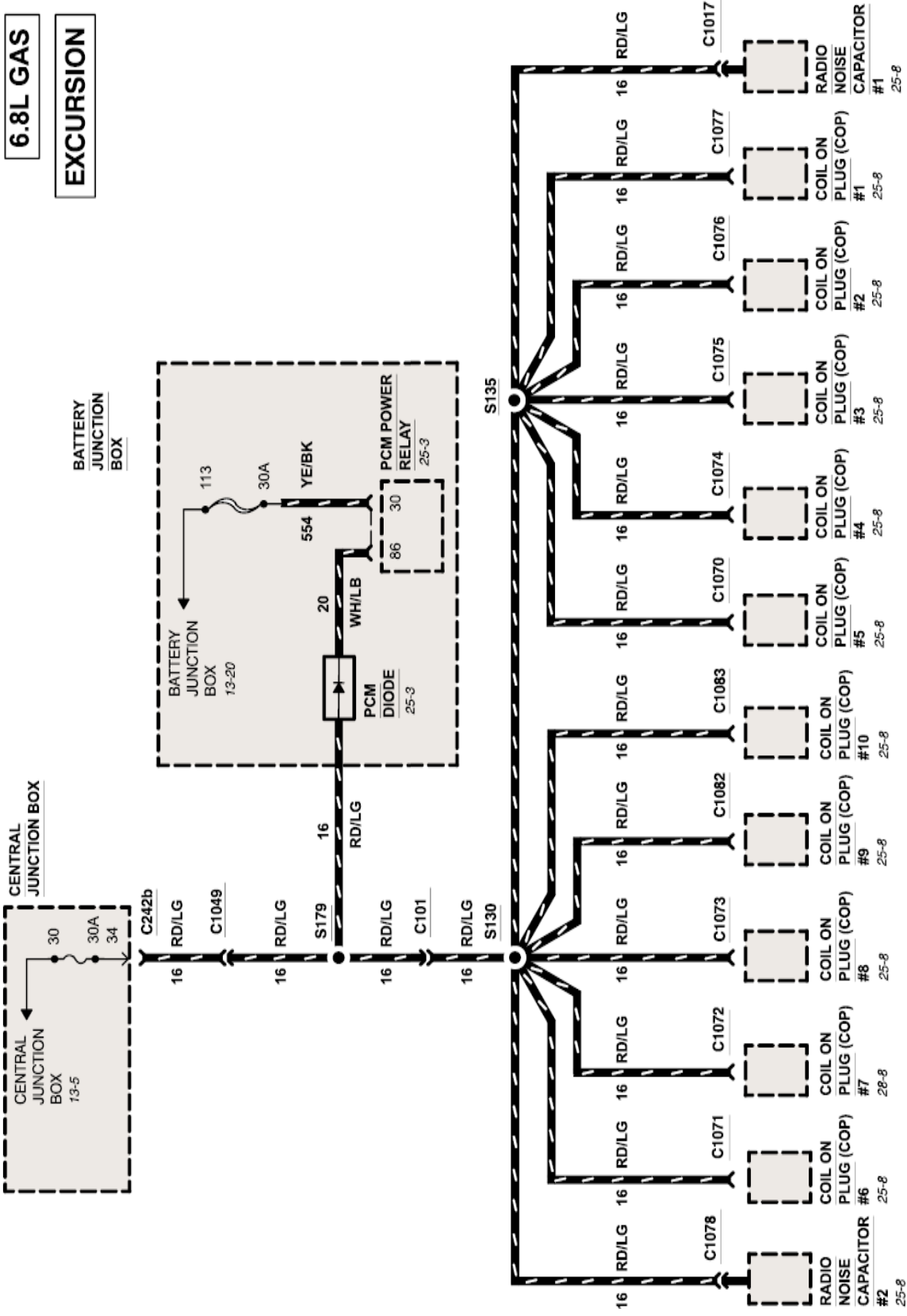

# POWER DISTRIBUTION 13-8

2000 EXCURSION, SUPER DUTY SERIES F-250, F-350, F-450, F-550

5.4L GAS

EXCURSION

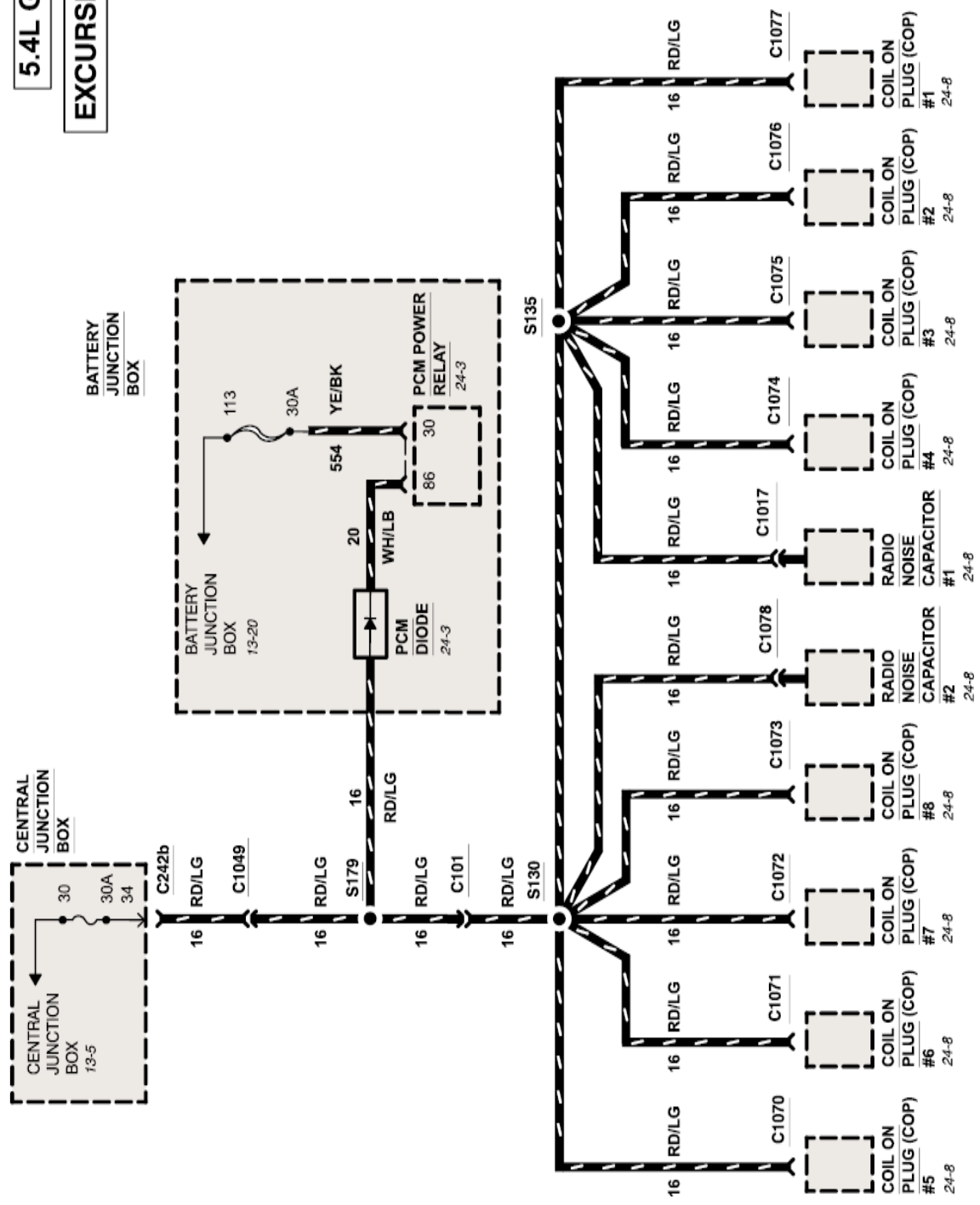



# 13-9 POWER DISTRIBUTION

2000 EXCURSION, SUPER DUTY SERIES F-250, F-350, F-450, F-550

## EXCURSION

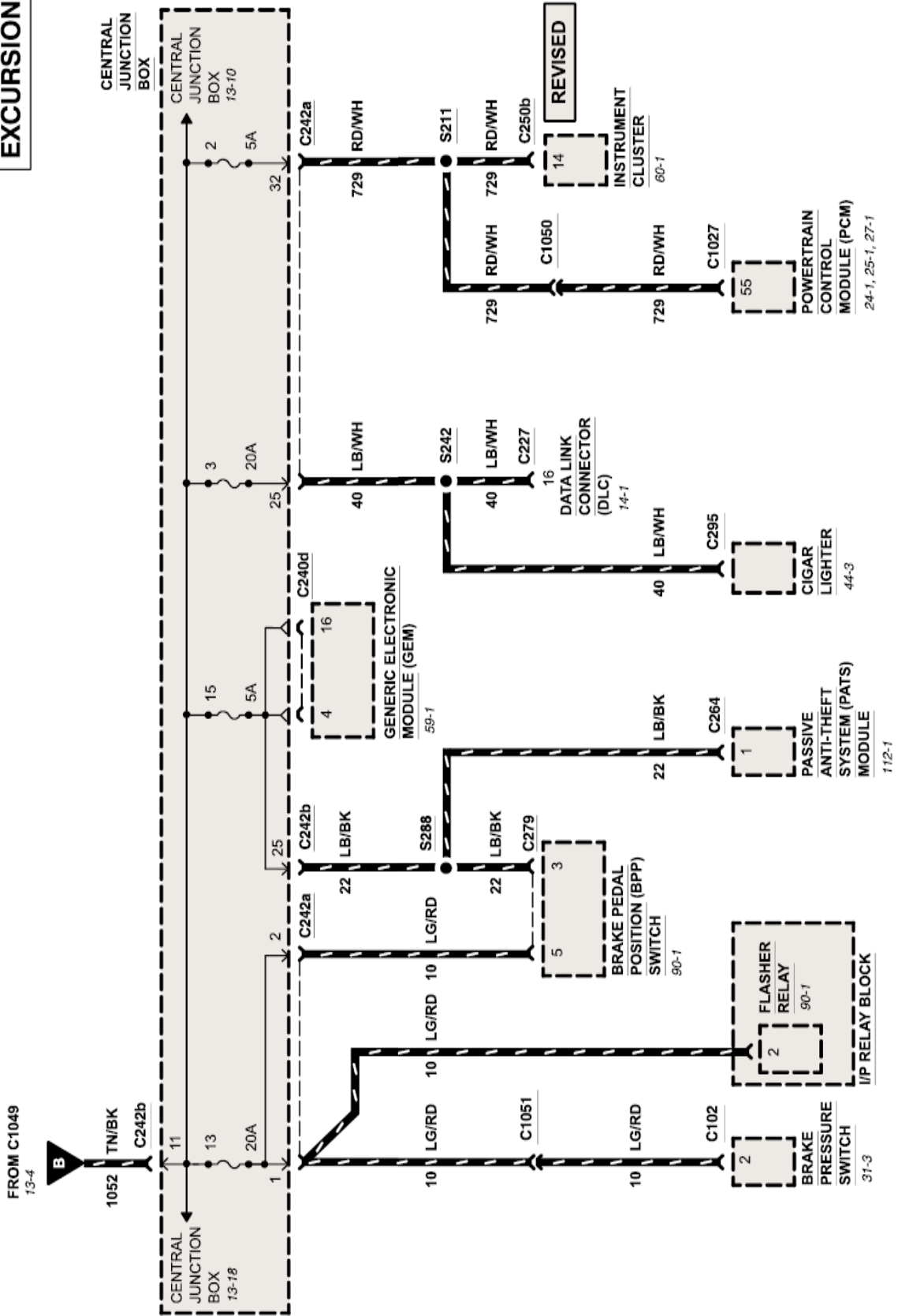

# POWER DISTRIBUTION 13-10

2000 EXCURSION, SUPER DUTY SERIES F-250, F-350, F-450, F-550

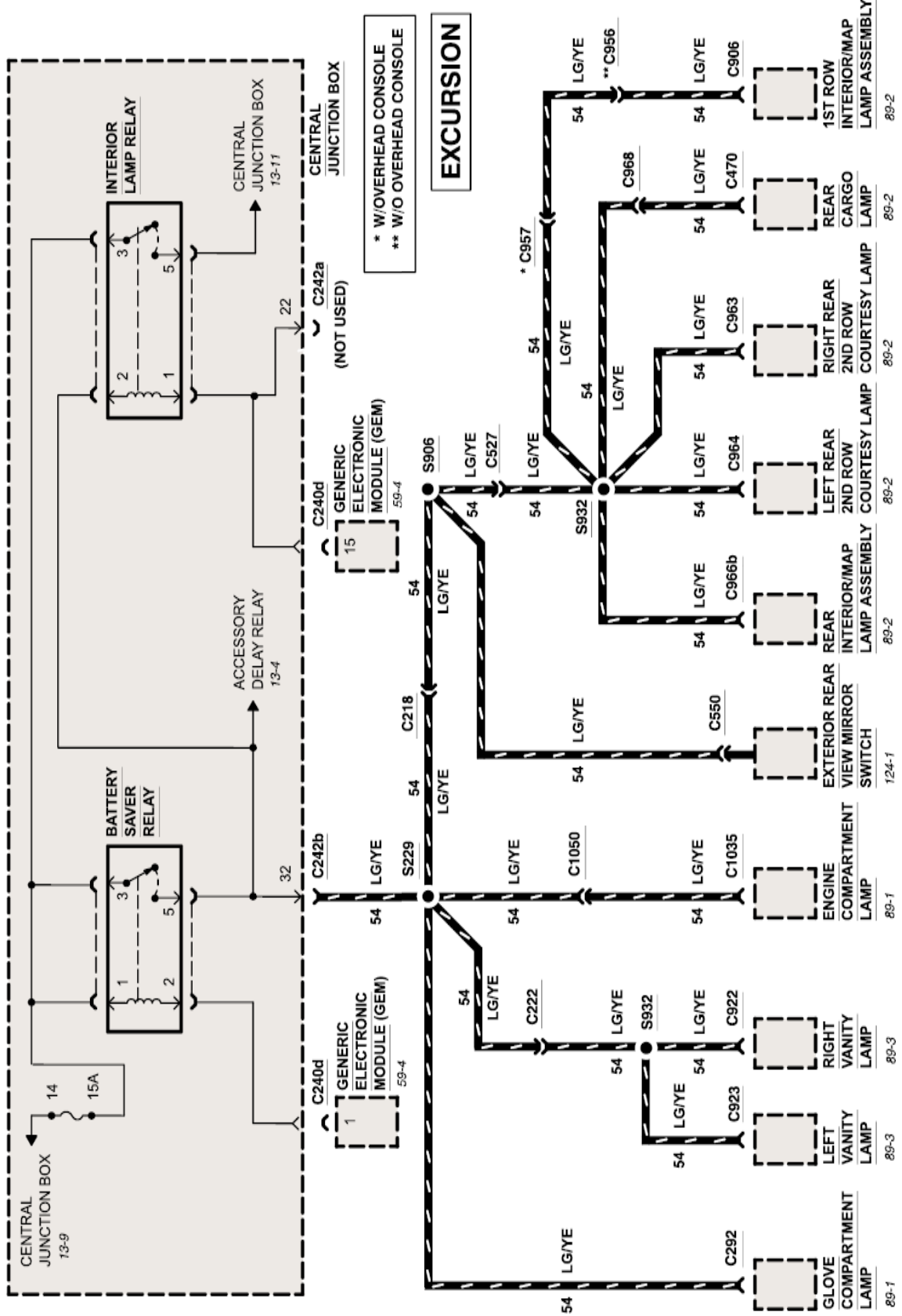

# 13-11 POWER DISTRIBUTION

2000 EXCURSION, SUPER DUTY SERIES F-250, F-350, F-450, F-550

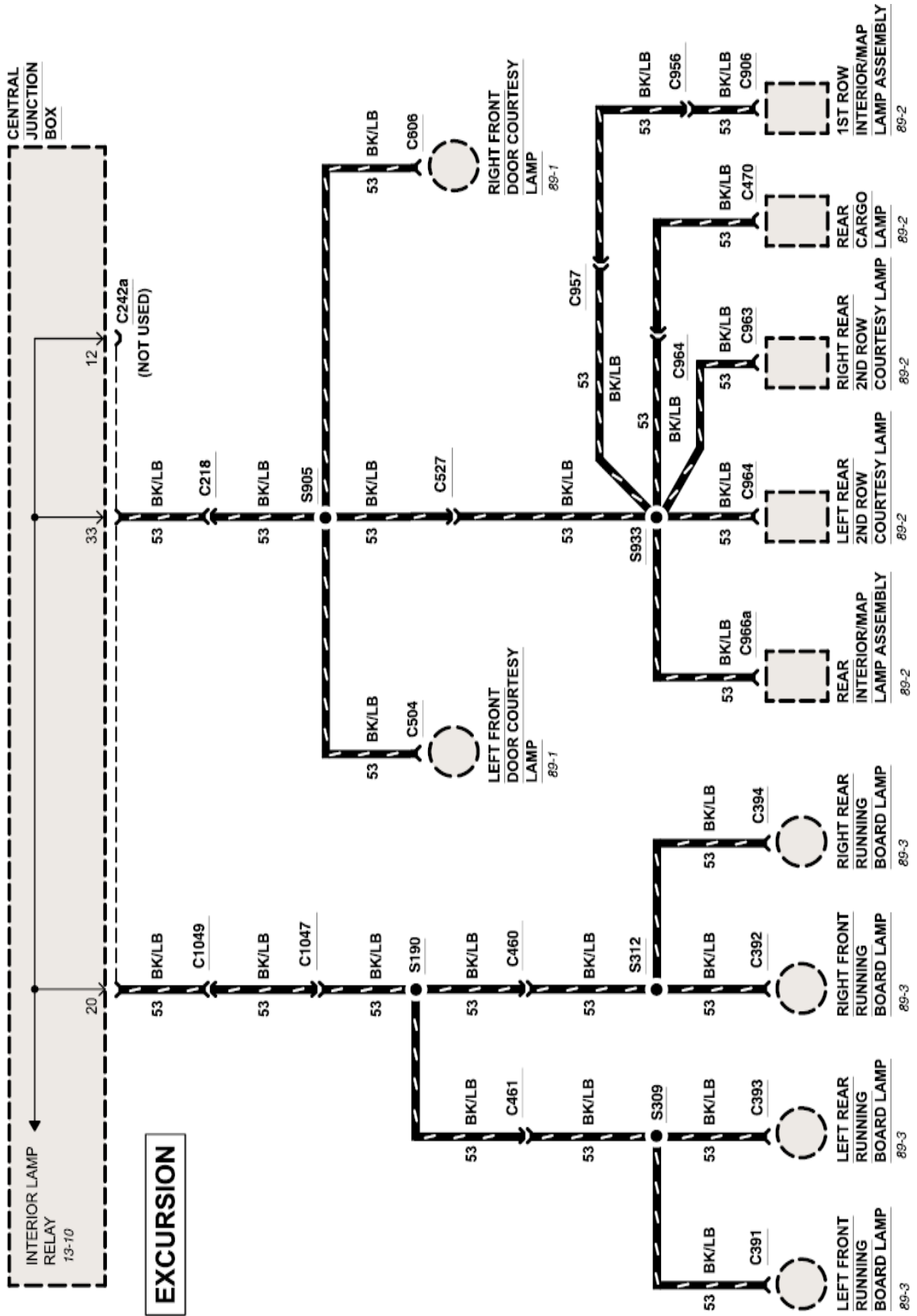

# POWER DISTRIBUTION 13-12

2000 EXCURSION, SUPER DUTY SERIES F-250, F-350, F-450, F-550

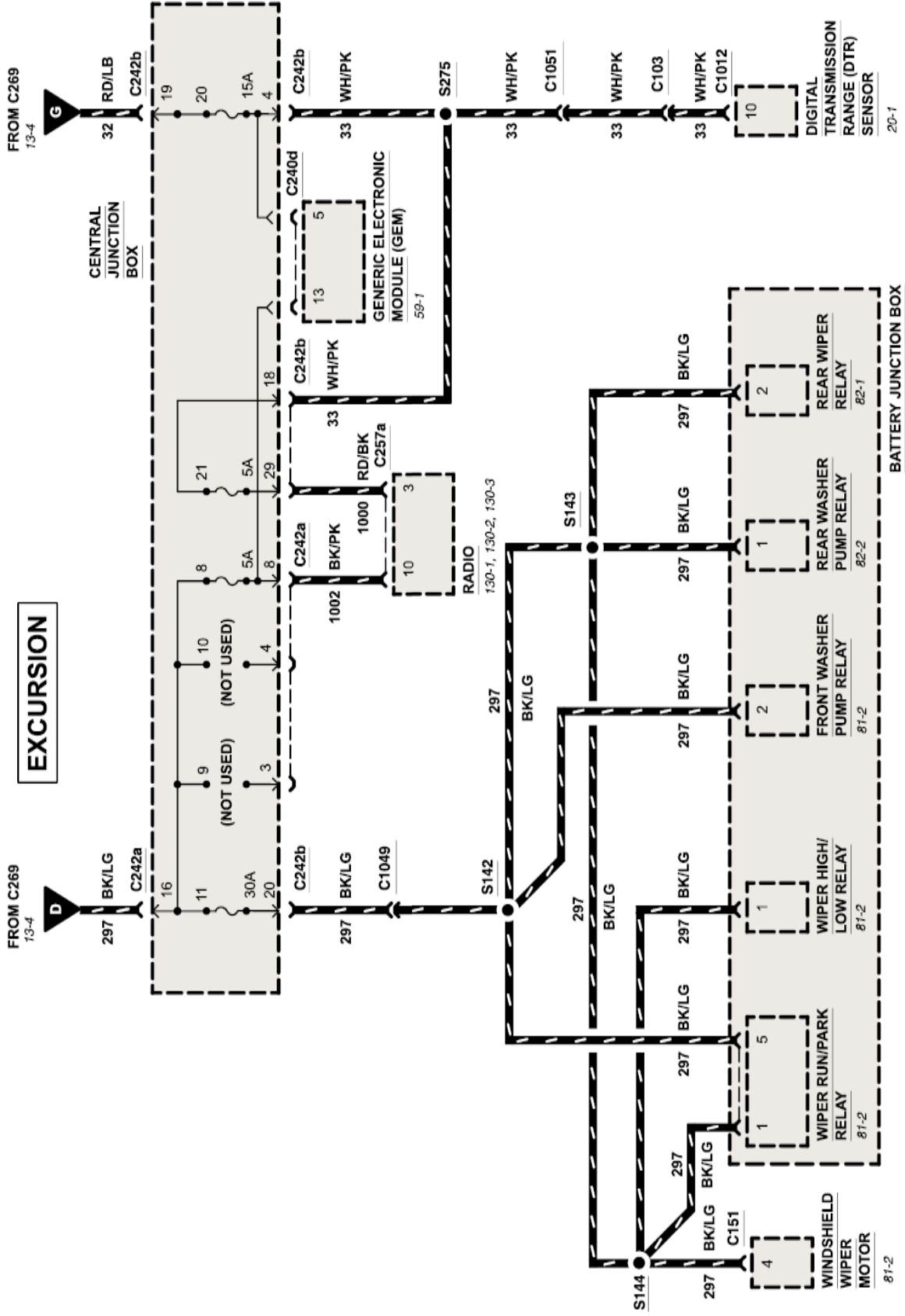

# 13-13 POWER DISTRIBUTION

2000 EXCURSION, SUPER DUTY SERIES F-250, F-350, F-450, F-550

**EXCURSION**

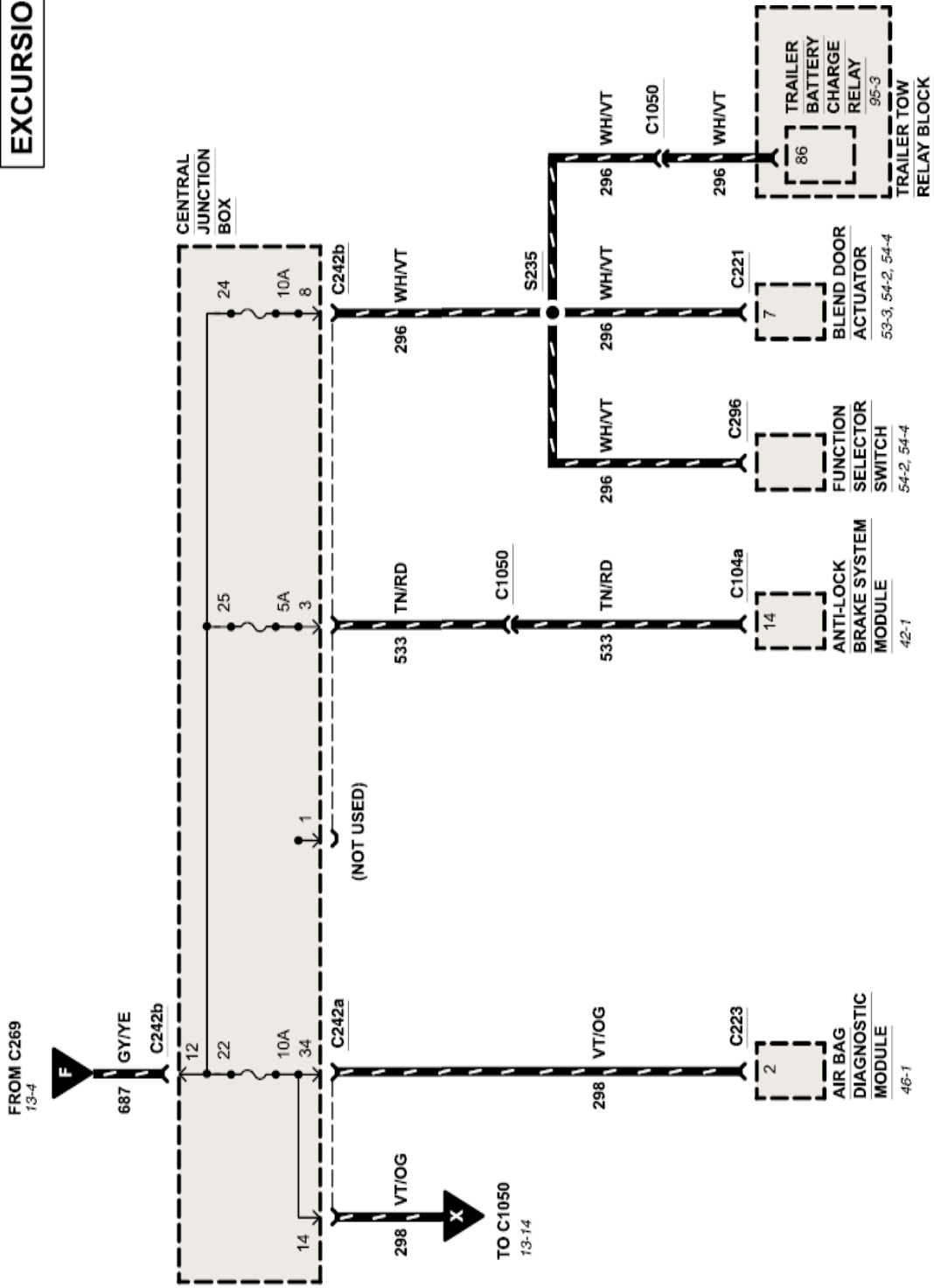

# POWER DISTRIBUTION 13-14

2000 EXCURSION, SUPER DUTY SERIES F-250, F-350, F-450, F-550

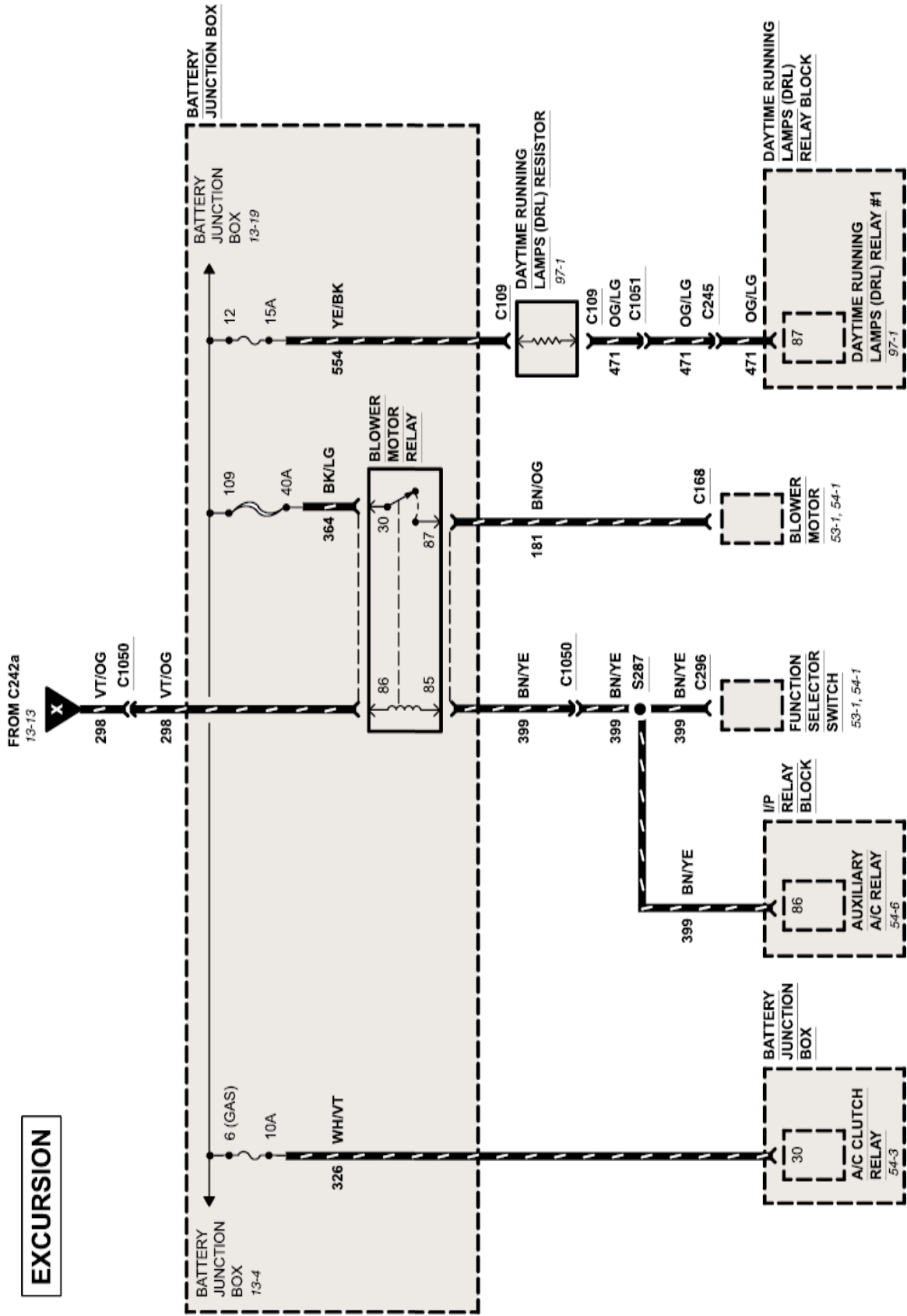

# 13-15 POWER DISTRIBUTION

2000 EXCURSION, SUPER DUTY SERIES F-250, F-350, F-450, F-550

## EXCURSION

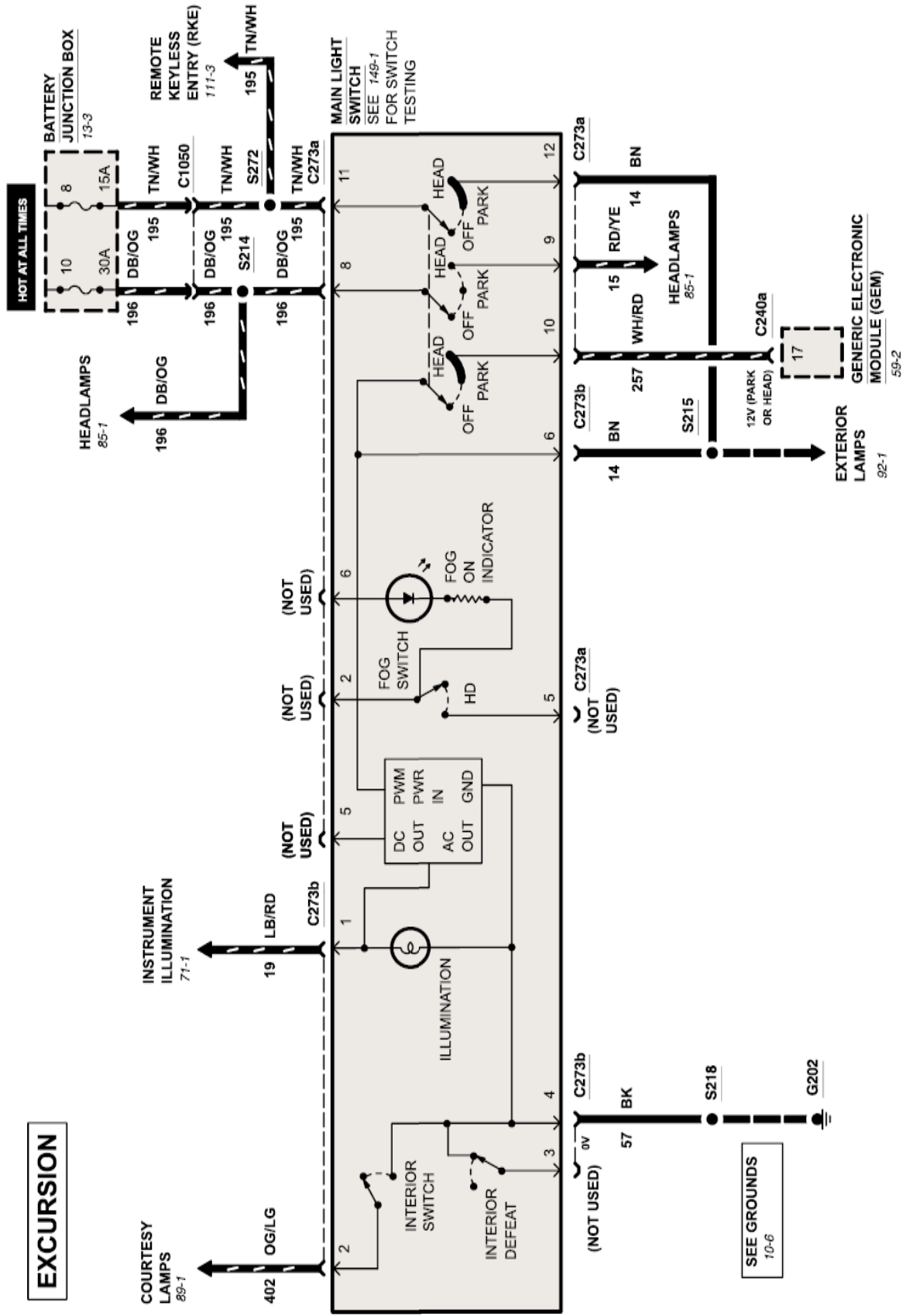





# 13-17 POWER DISTRIBUTION

2000 EXCURSION, SUPER DUTY SERIES F-250, F-350, F-450, F-550

## EXCURSION

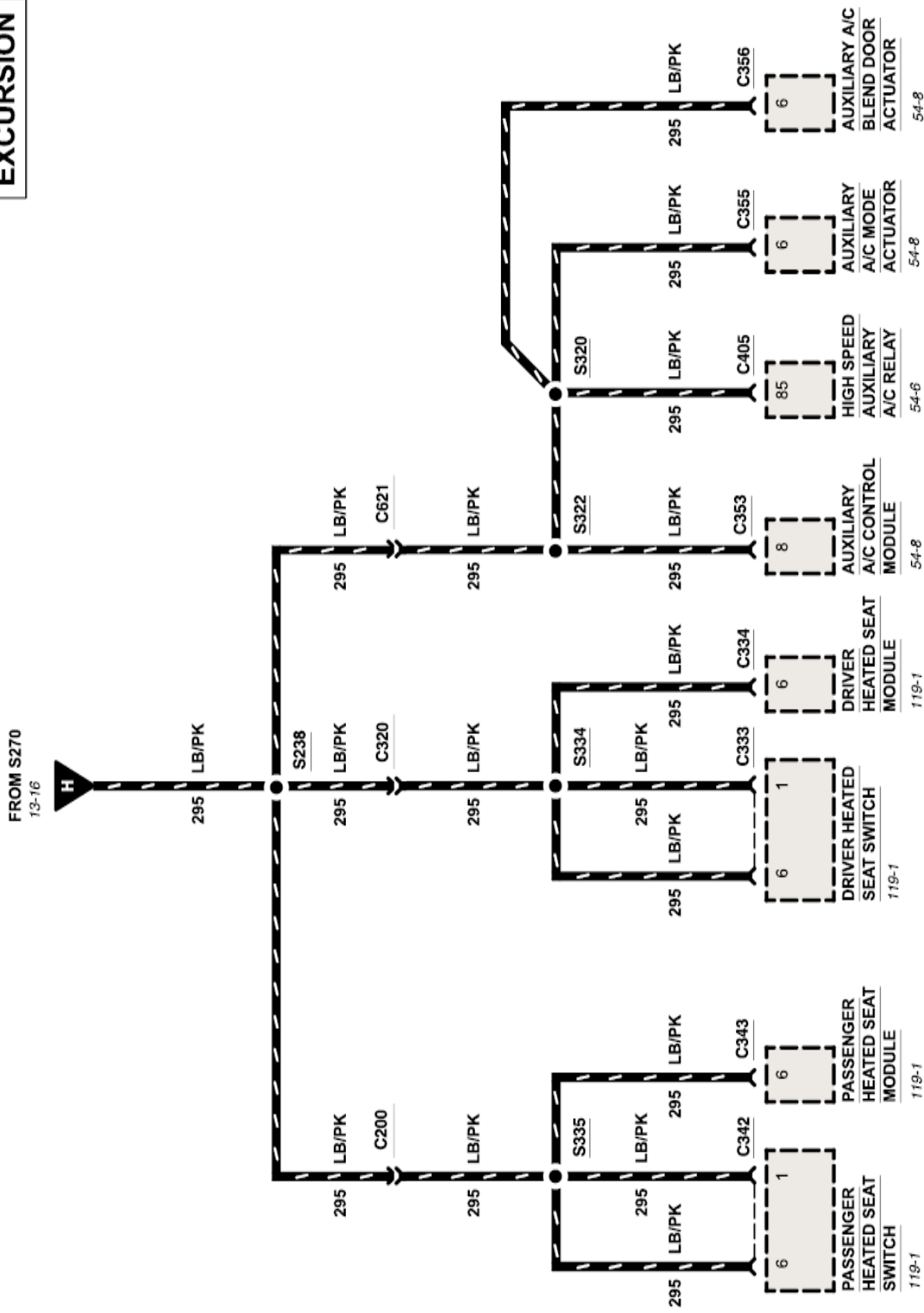

# POWER DISTRIBUTION 13-18

2000 EXCURSION, SUPER DUTY SERIES F-250, F-350, F-450, F-550

**EXCURSION**

**HOT AT ALL TIMES**

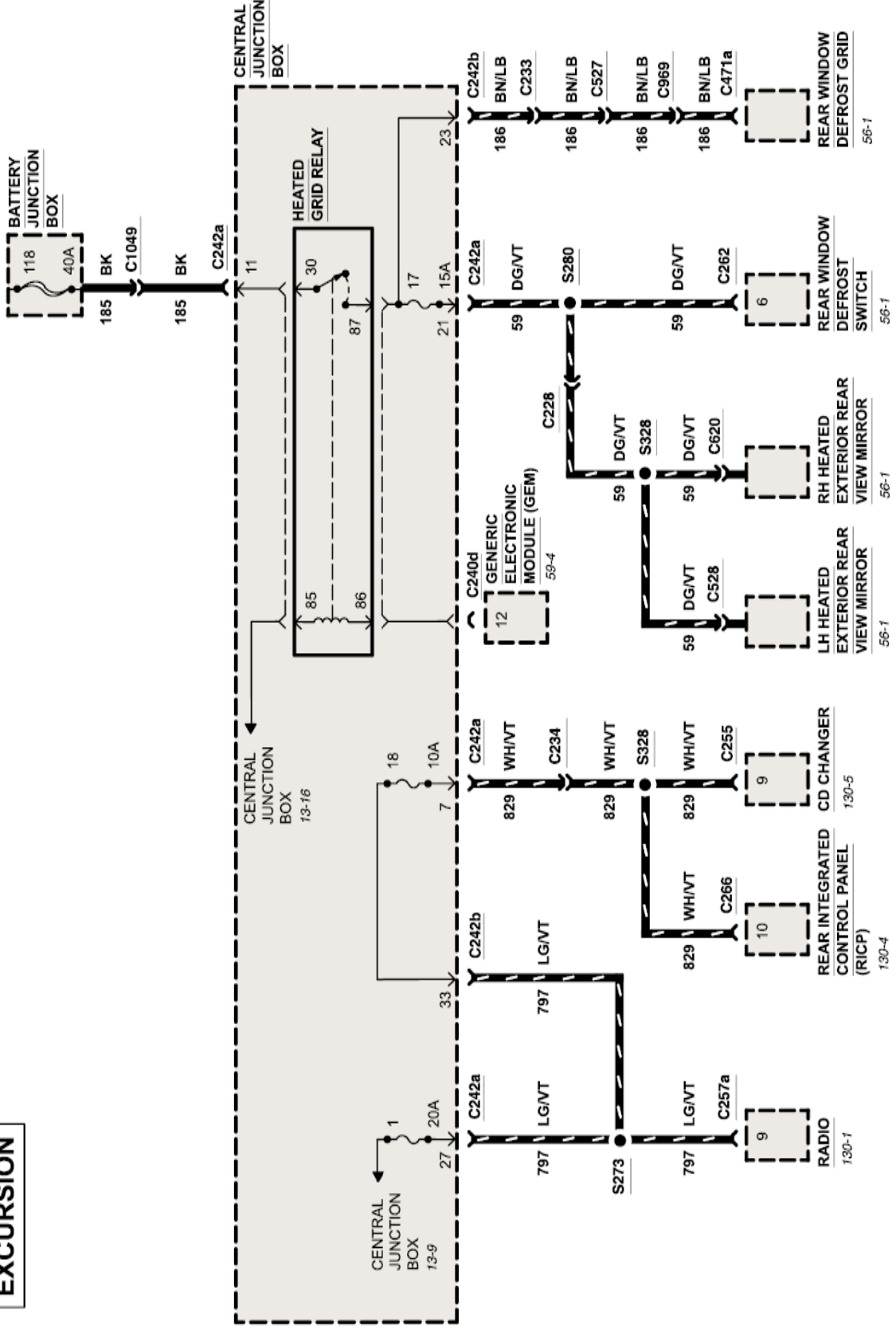

# 13-19 POWER DISTRIBUTION

2000 EXCURSION, SUPER DUTY SERIES F-250, F-350, F-450, F-550

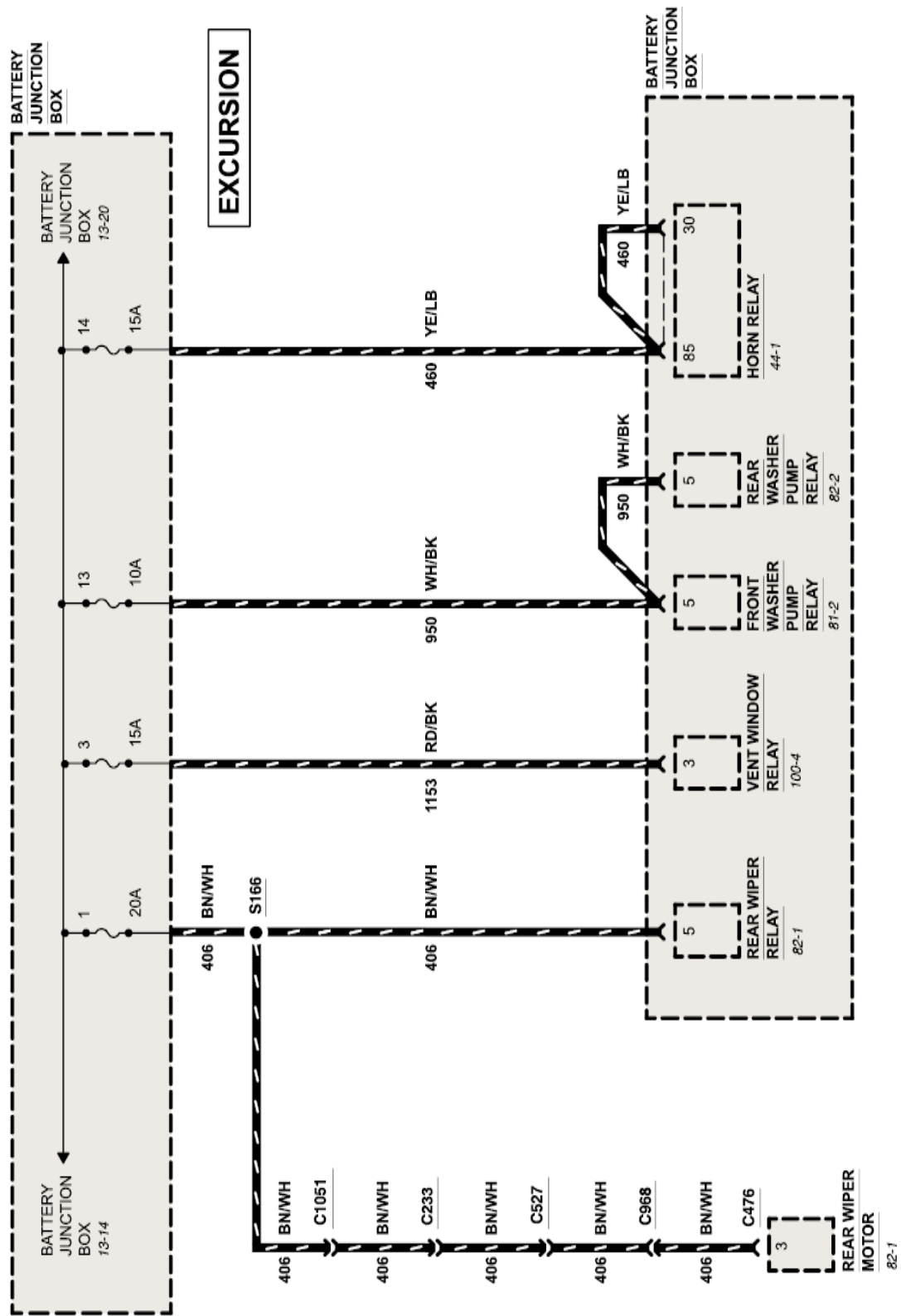

# POWER DISTRIBUTION 13-20

2000 EXCURSION, SUPER DUTY SERIES F-250, F-350, F-450, F-550

## EXCURSION

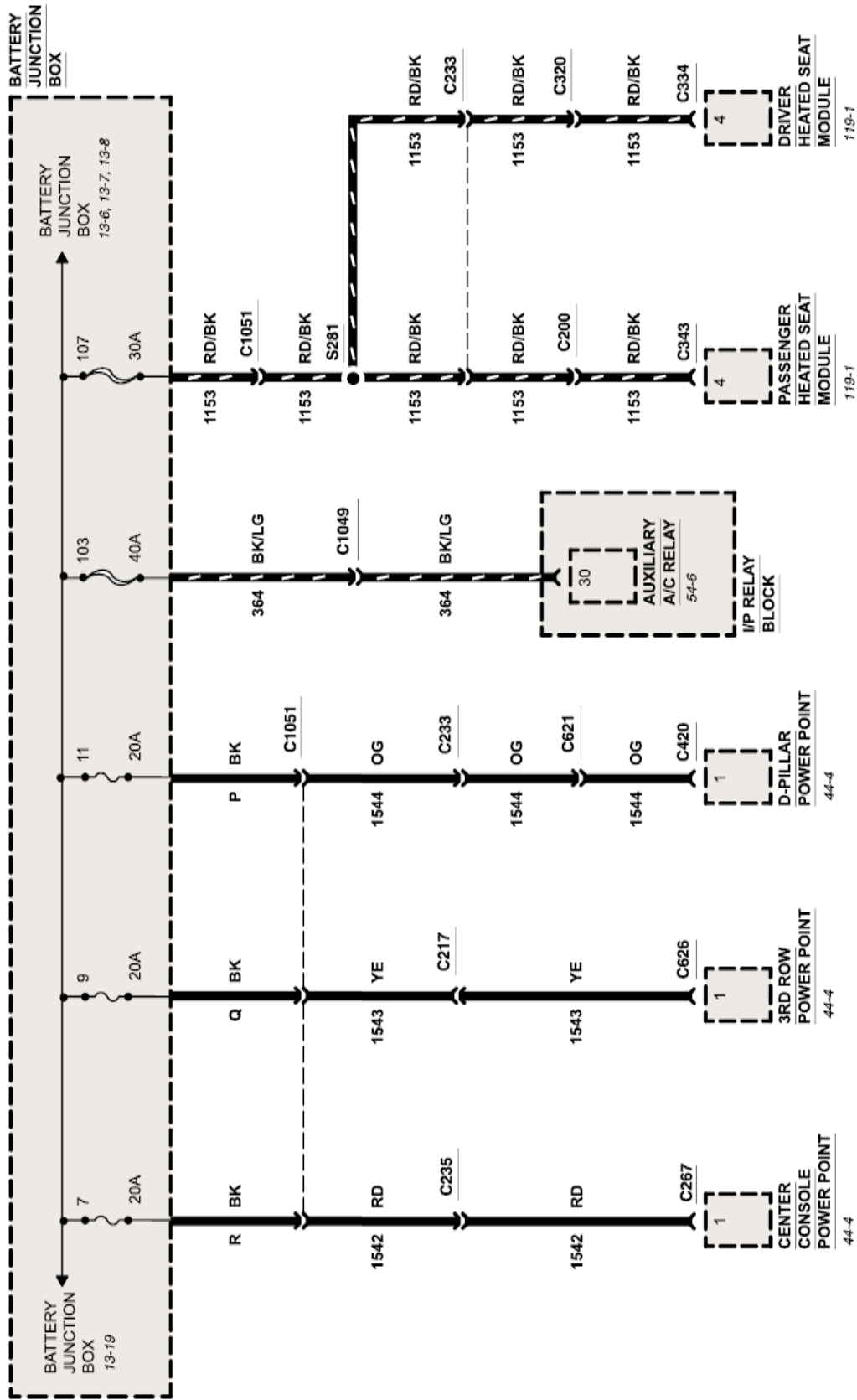

# 13-21 POWER DISTRIBUTION

2000 EXCURSION, SUPER DUTY SERIES F-250, F-350, F-450, F-550

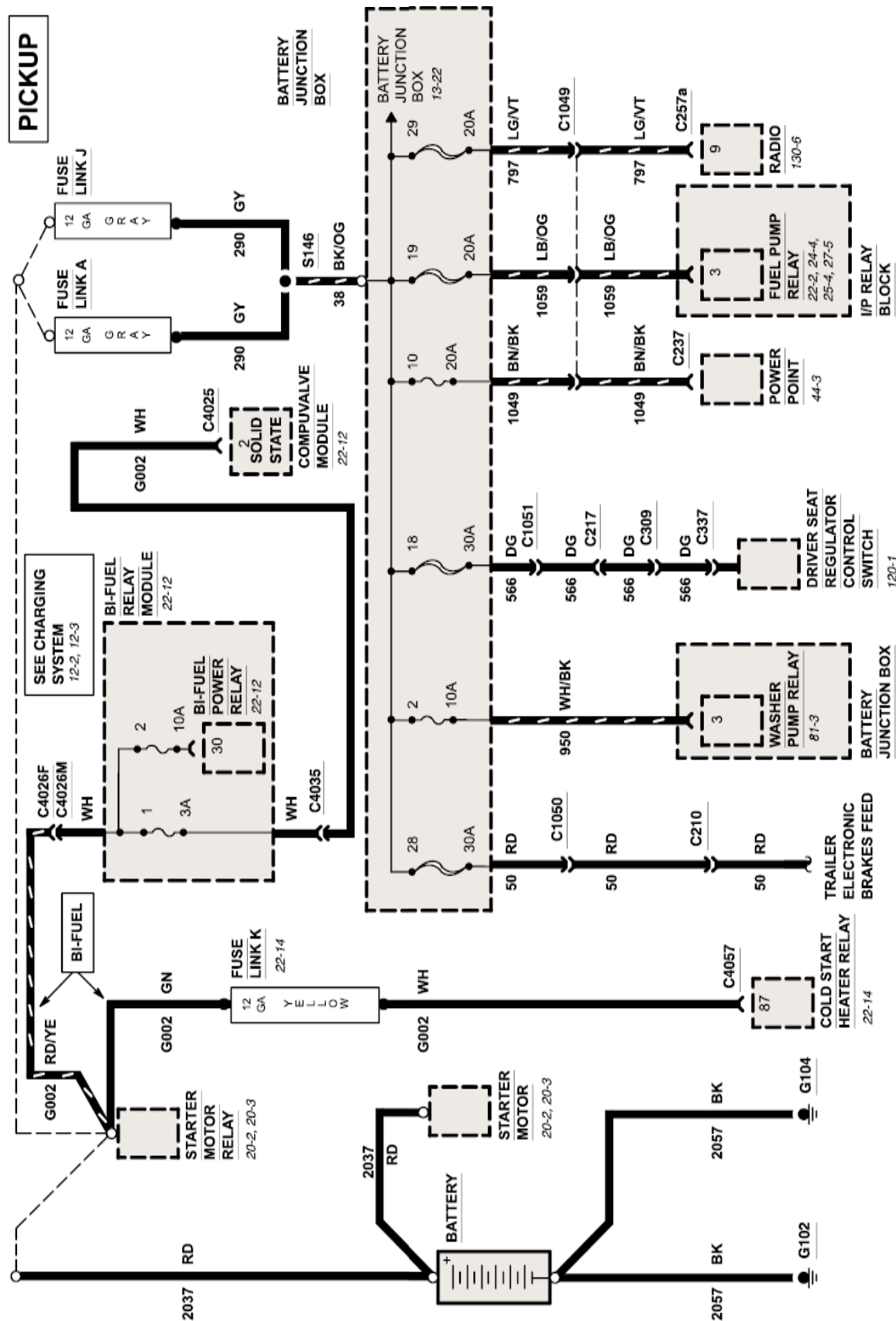

# POWER DISTRIBUTION 13-22

2000 EXCURSION, SUPER DUTY SERIES F-250, F-350, F-450, F-550

PICKUP

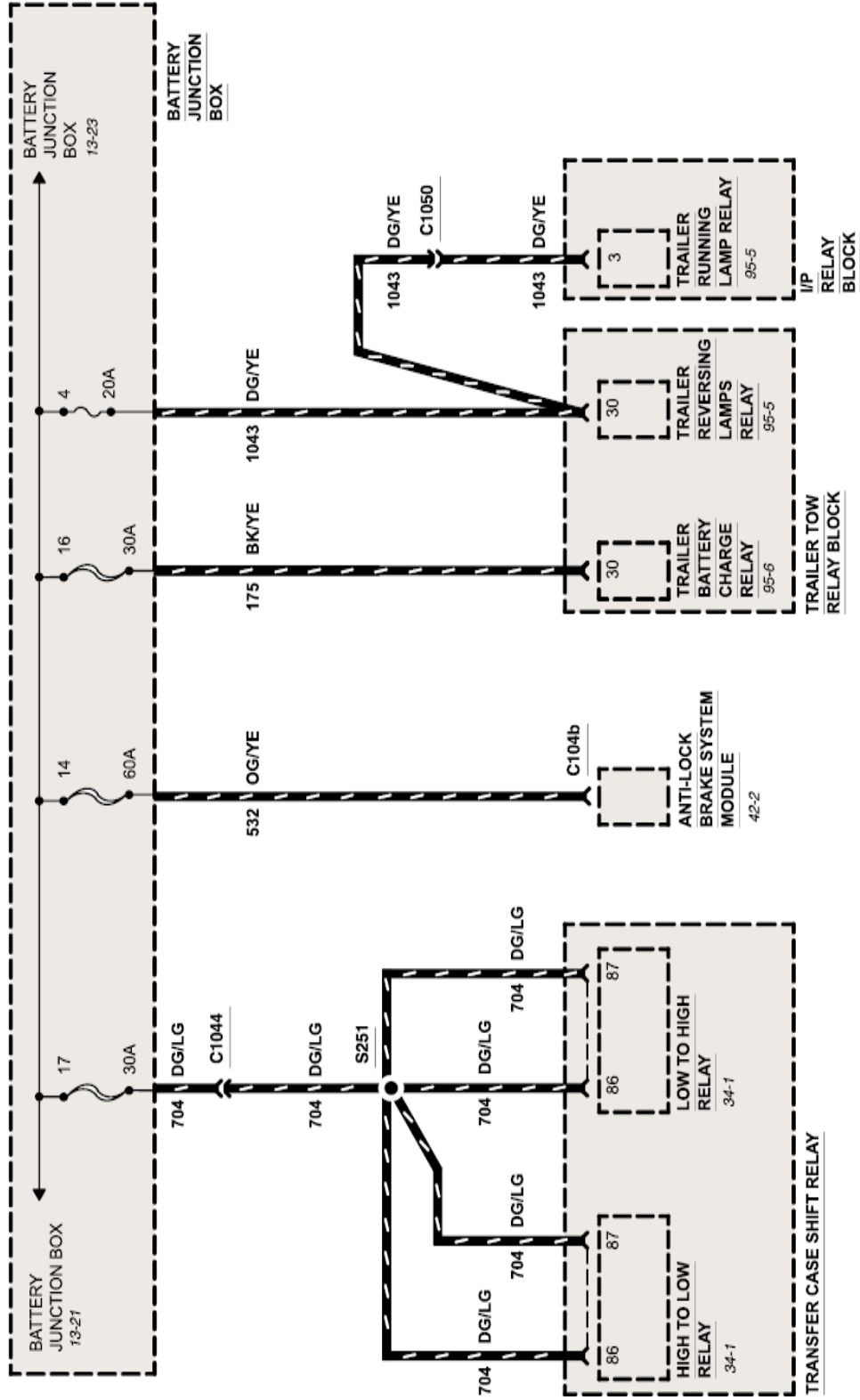

# 13-23 POWER DISTRIBUTION

2000 EXCURSION, SUPER DUTY SERIES F-250, F-350, F-450, F-550

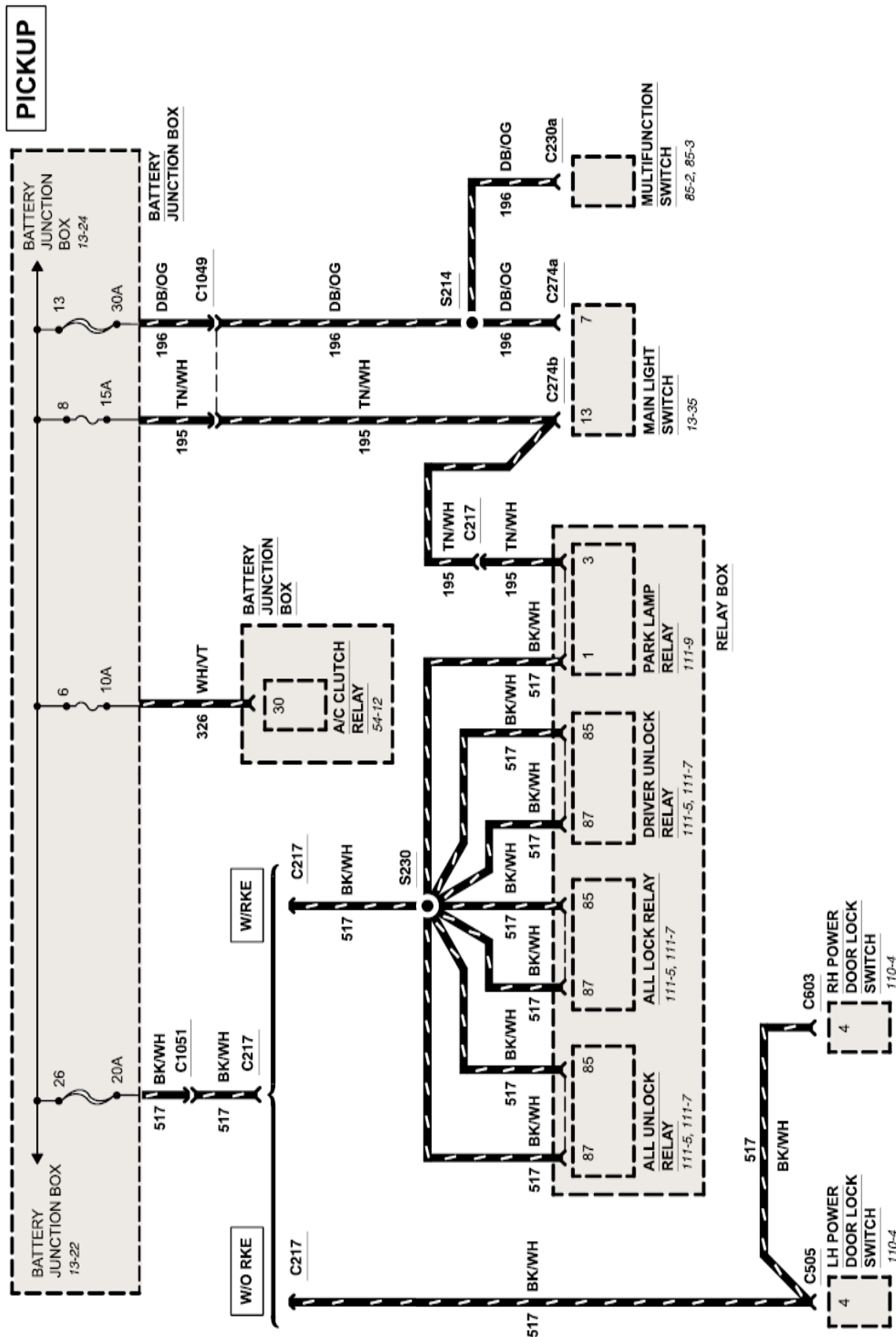

# POWER DISTRIBUTION 13-24

2000 EXCURSION, SUPER DUTY SERIES F-250, F-350, F-450, F-550

PICKUP

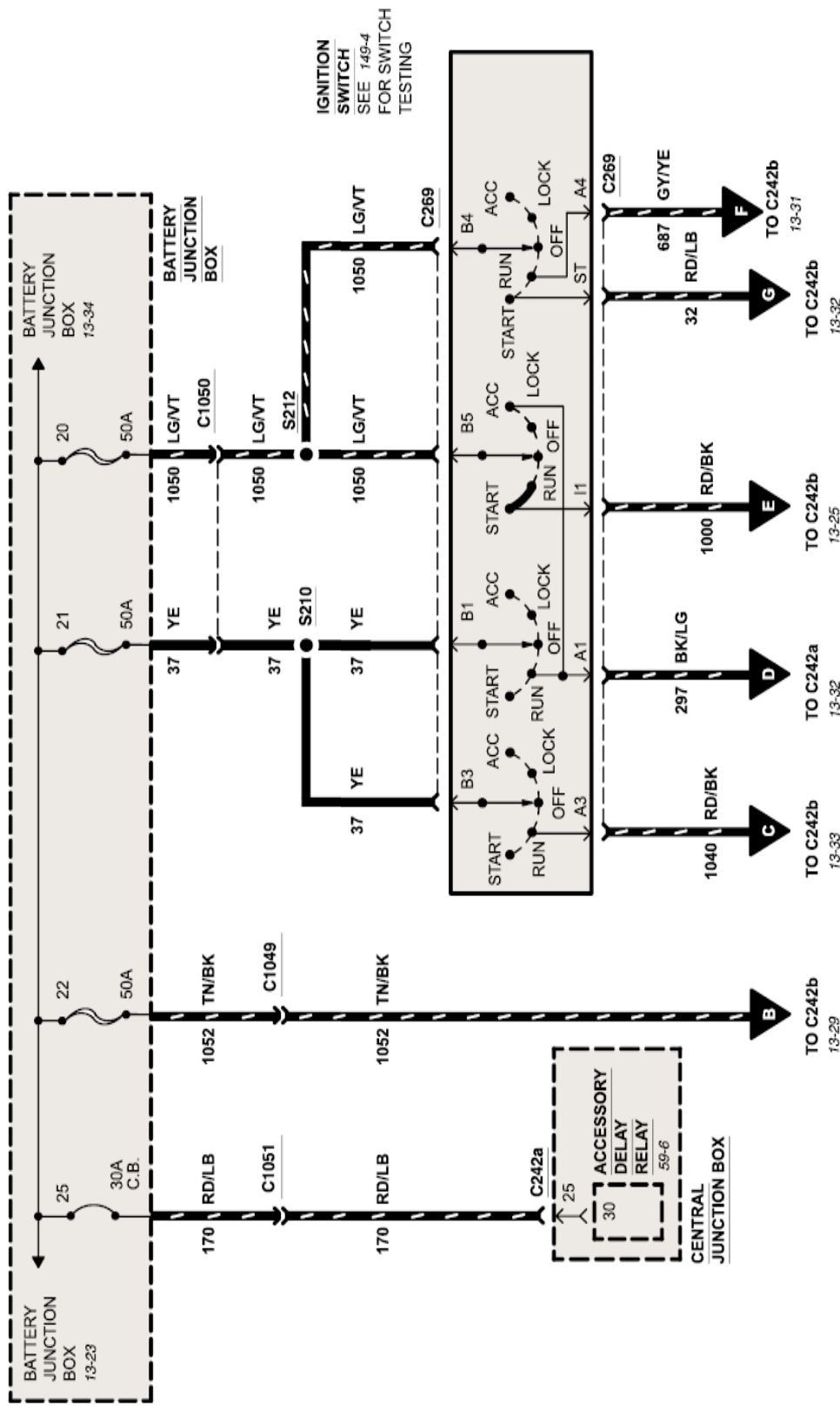



# 13-25 POWER DISTRIBUTION

2000 EXCURSION, SUPER DUTY SERIES F-250, F-350, F-450, F-550

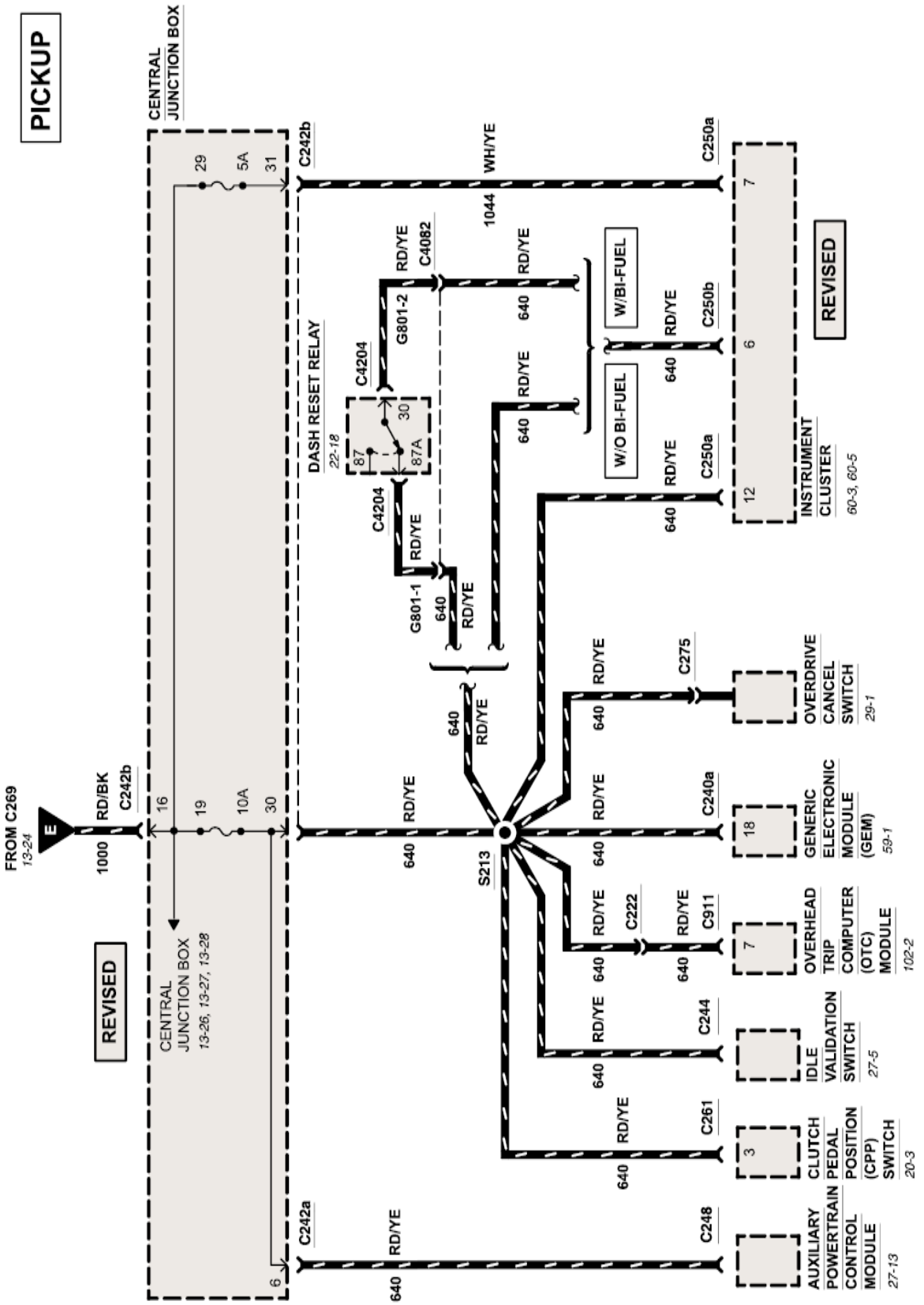

PICKUP

REVISED

REVISED

# POWER DISTRIBUTION 13-26

2000 EXCURSION, SUPER DUTY SERIES F-250, F-350, F-450, F-550

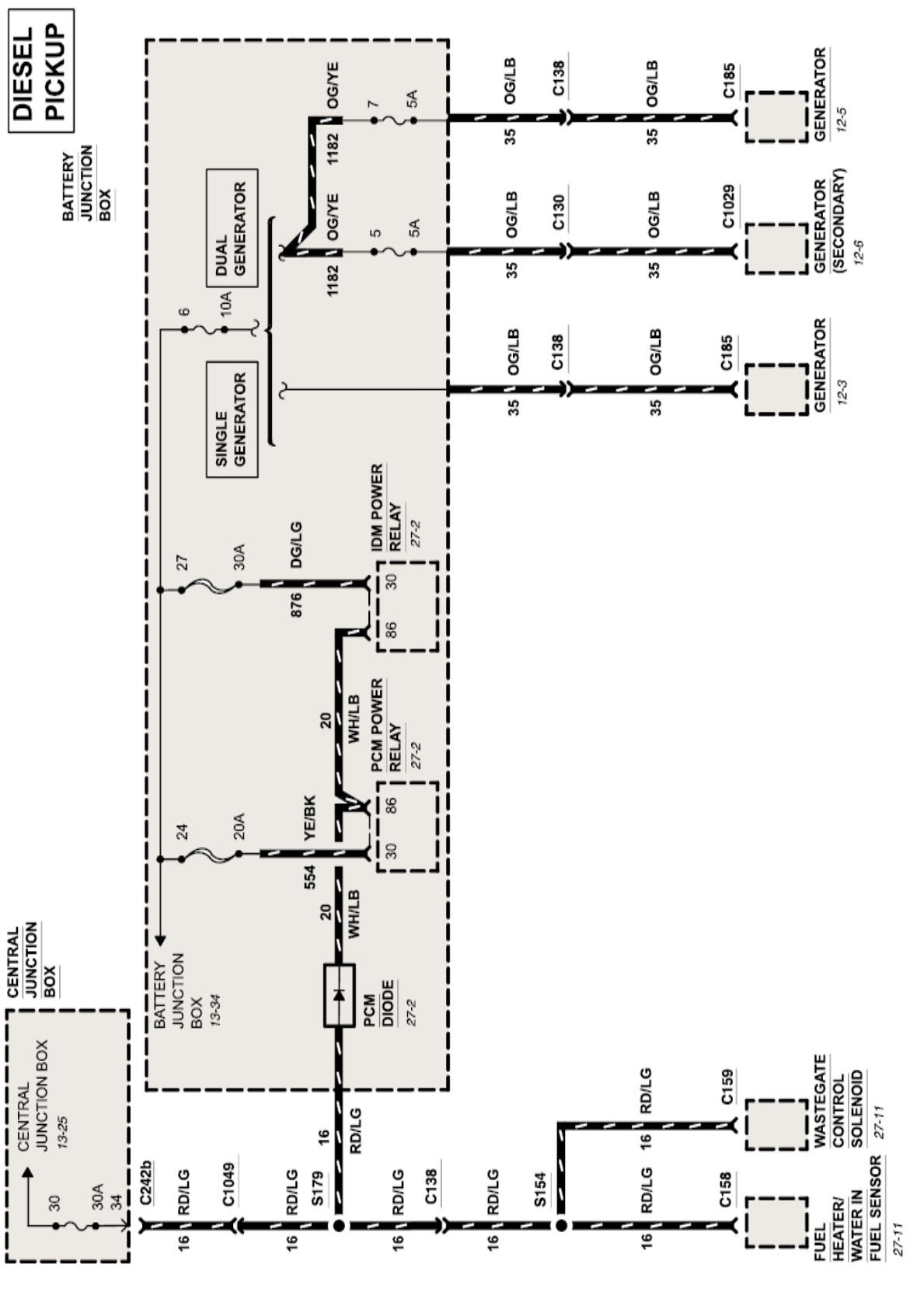

# 13-27 POWER DISTRIBUTION

2000 EXCURSION, SUPER DUTY SERIES F-250, F-350, F-450, F-550

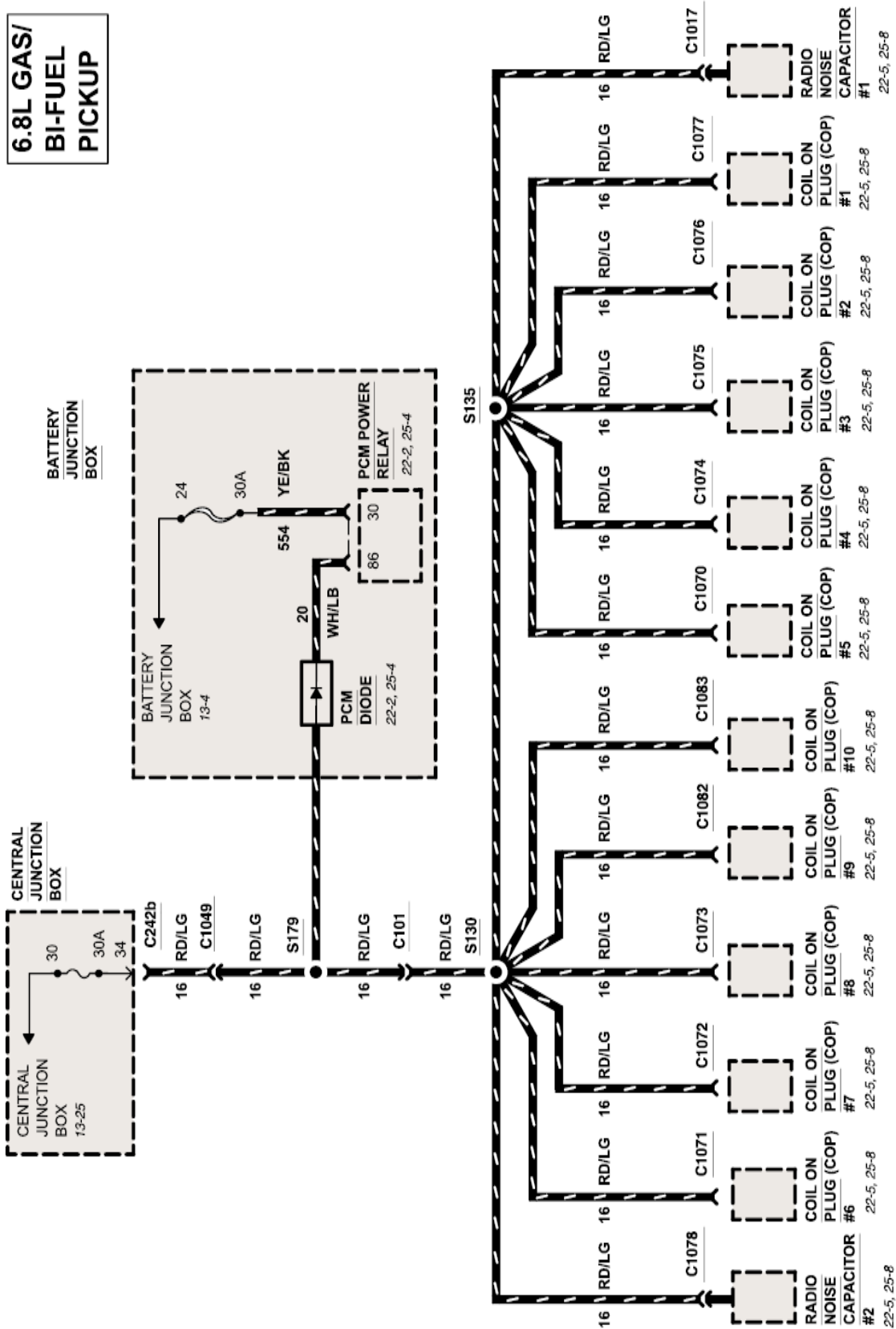

# POWER DISTRIBUTION 13-28

2000 EXCURSION, SUPER DUTY SERIES F-250, F-350, F-450, F-550

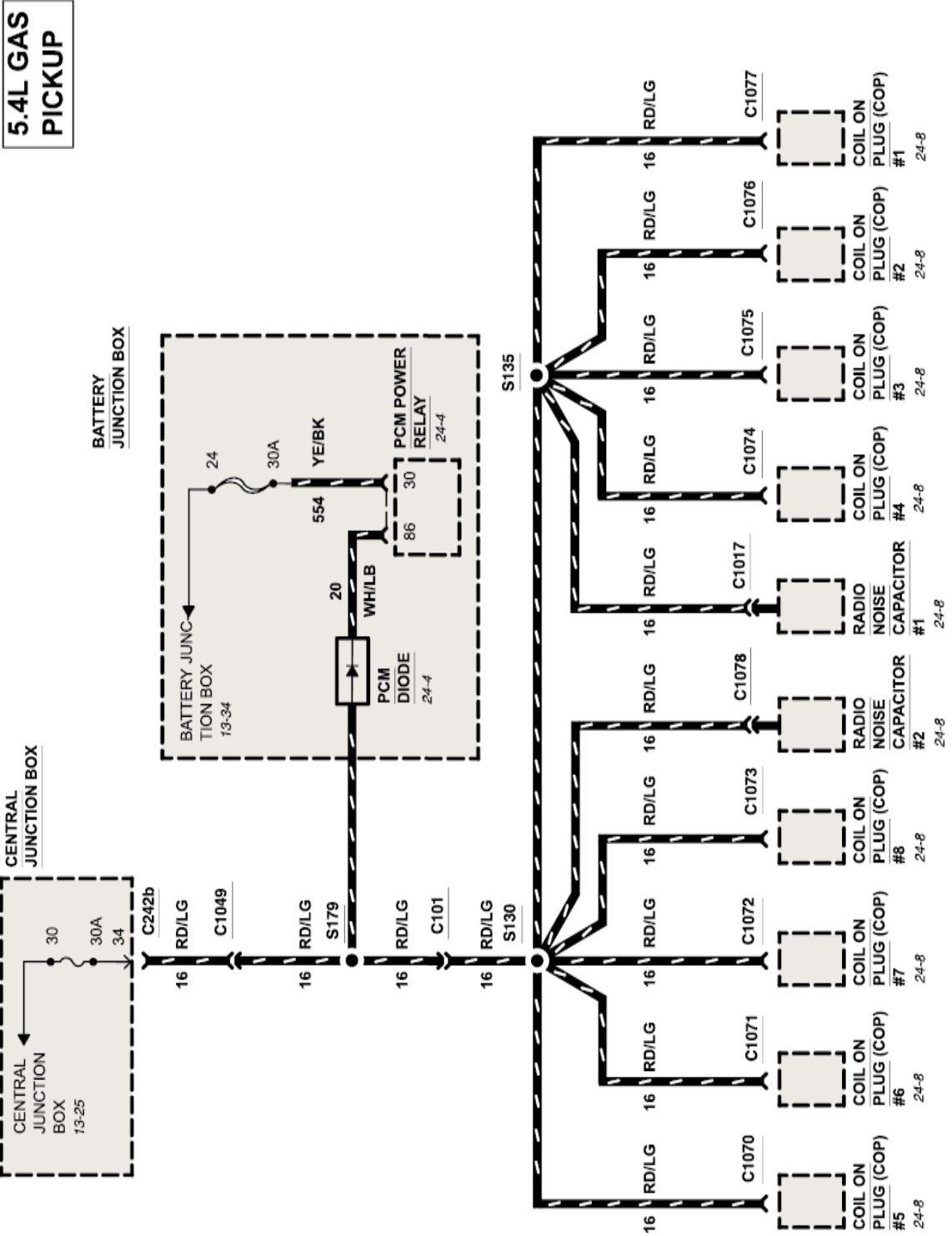

# 13-29 POWER DISTRIBUTION

2000 EXCURSION, SUPER DUTY SERIES F-250, F-350, F-450, F-550

PICKUP

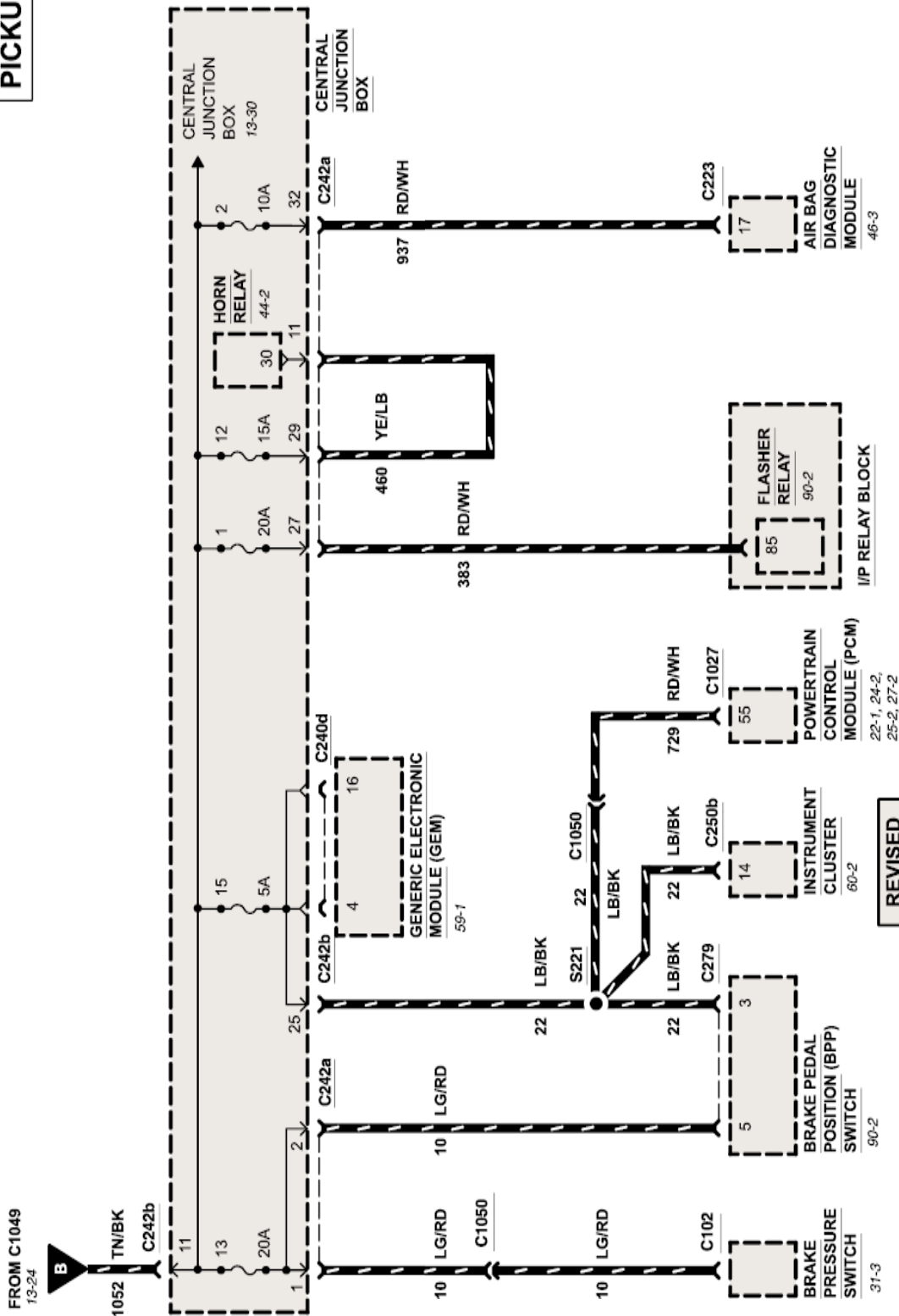

# POWER DISTRIBUTION 13-30

2000 EXCURSION, SUPER DUTY SERIES F-250, F-350, F-450, F-550

PICKUP

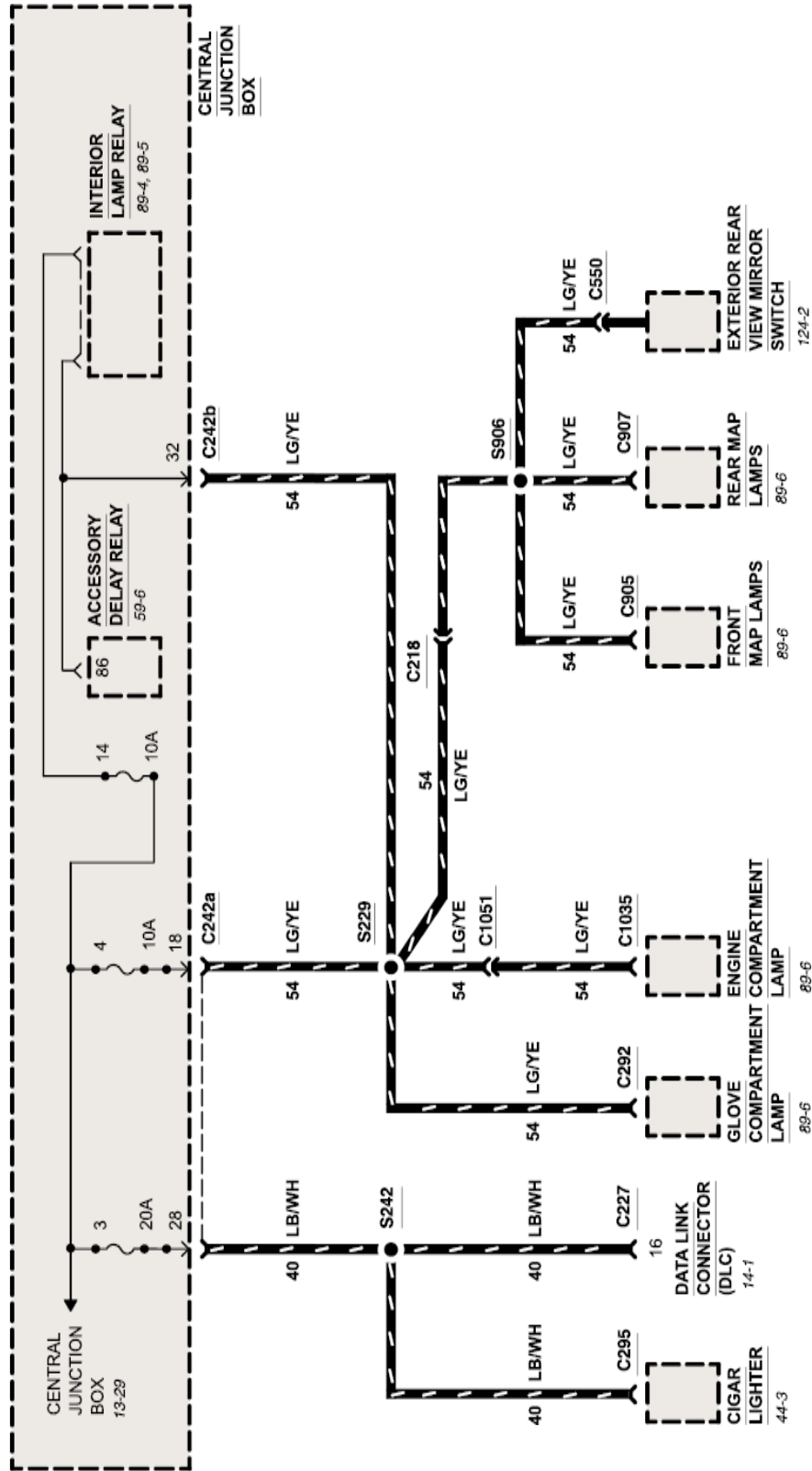

# 13-31 POWER DISTRIBUTION

2000 EXCURSION, SUPER DUTY SERIES F-250, F-350, F-450, F-550

PICKUP

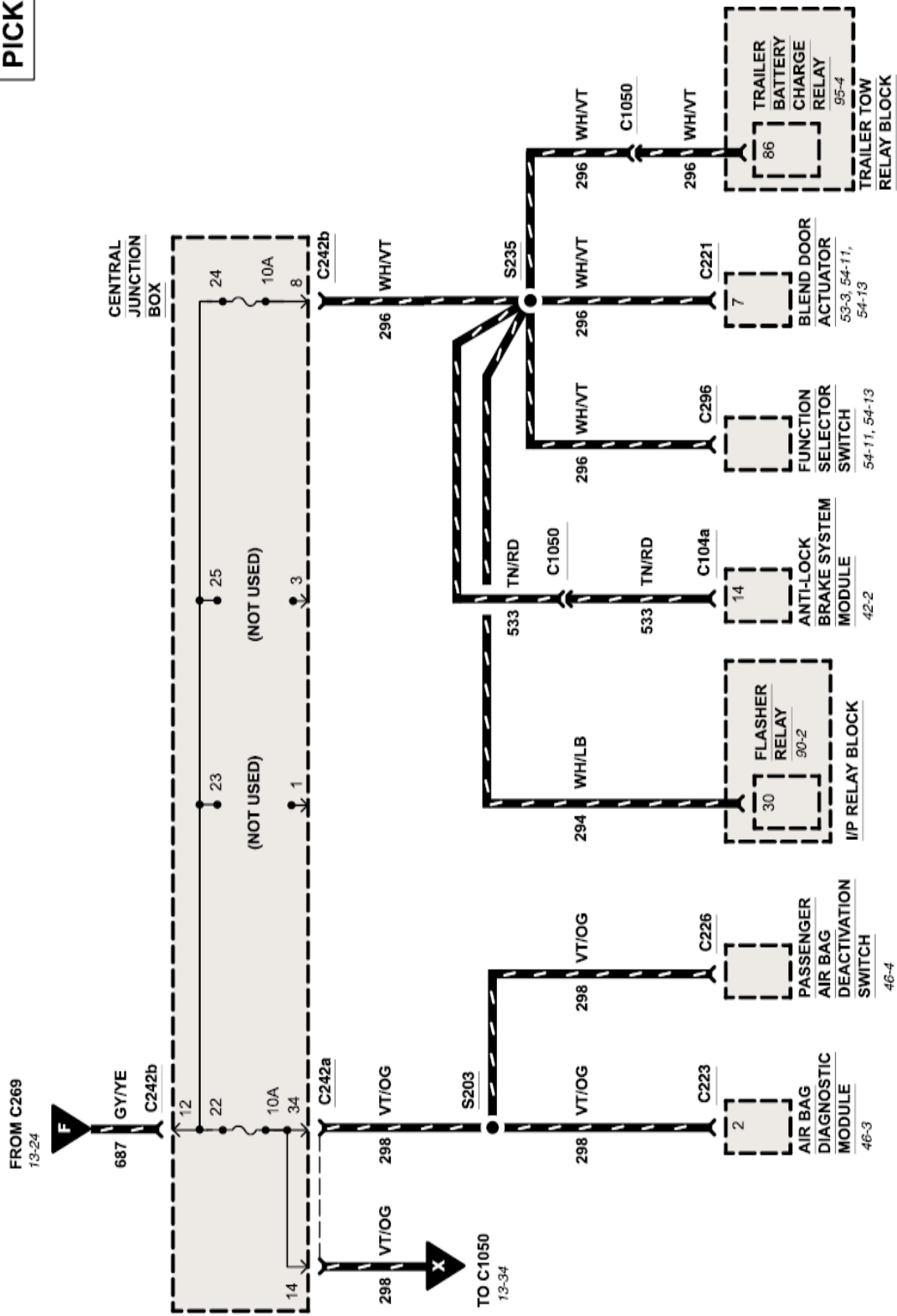

# POWER DISTRIBUTION 13-32

2000 EXCURSION, SUPER DUTY SERIES F-250, F-350, F-450, F-550

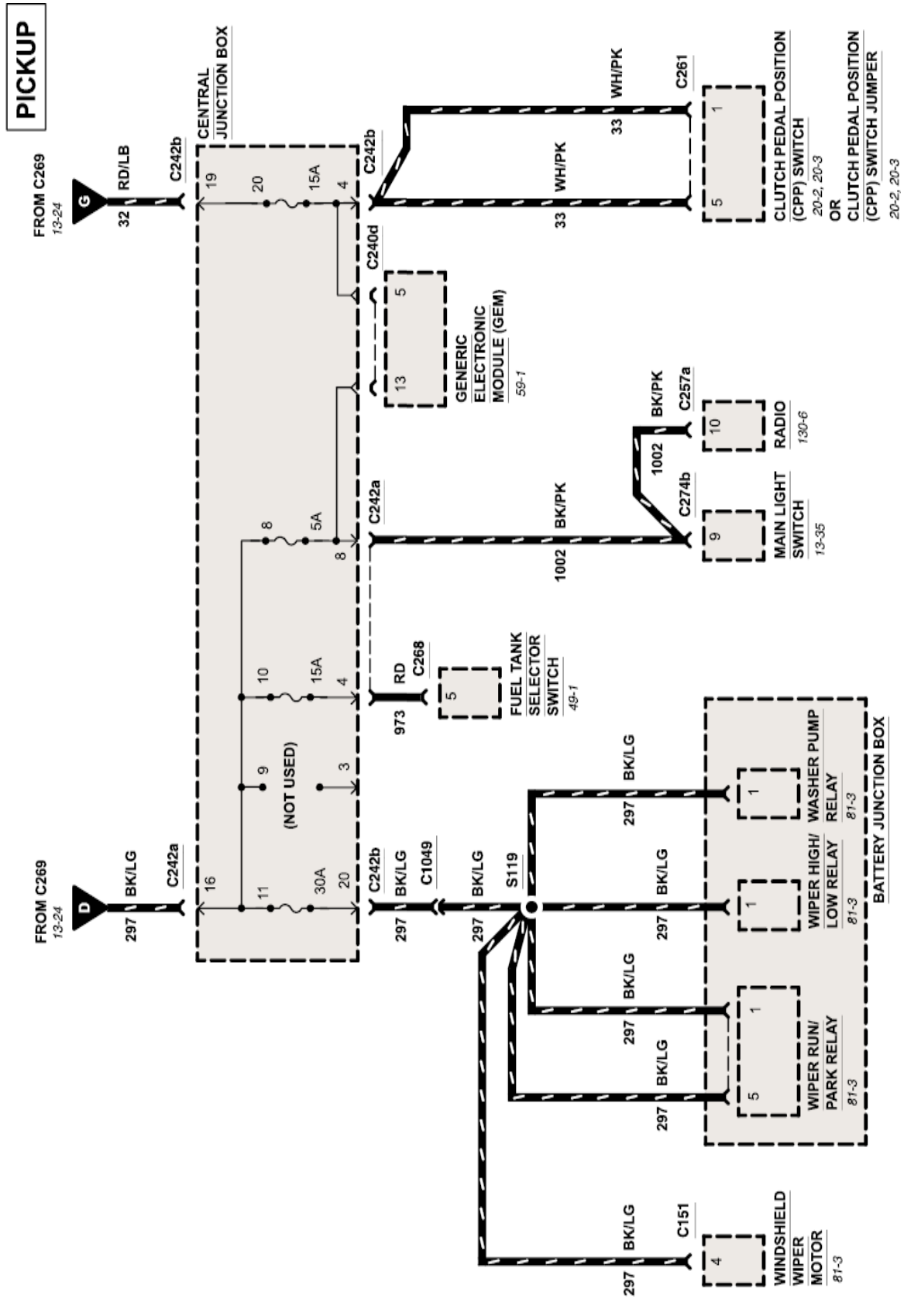



# 13-33 POWER DISTRIBUTION

2000 EXCURSION, SUPER DUTY SERIES F-250, F-350, F-450, F-550

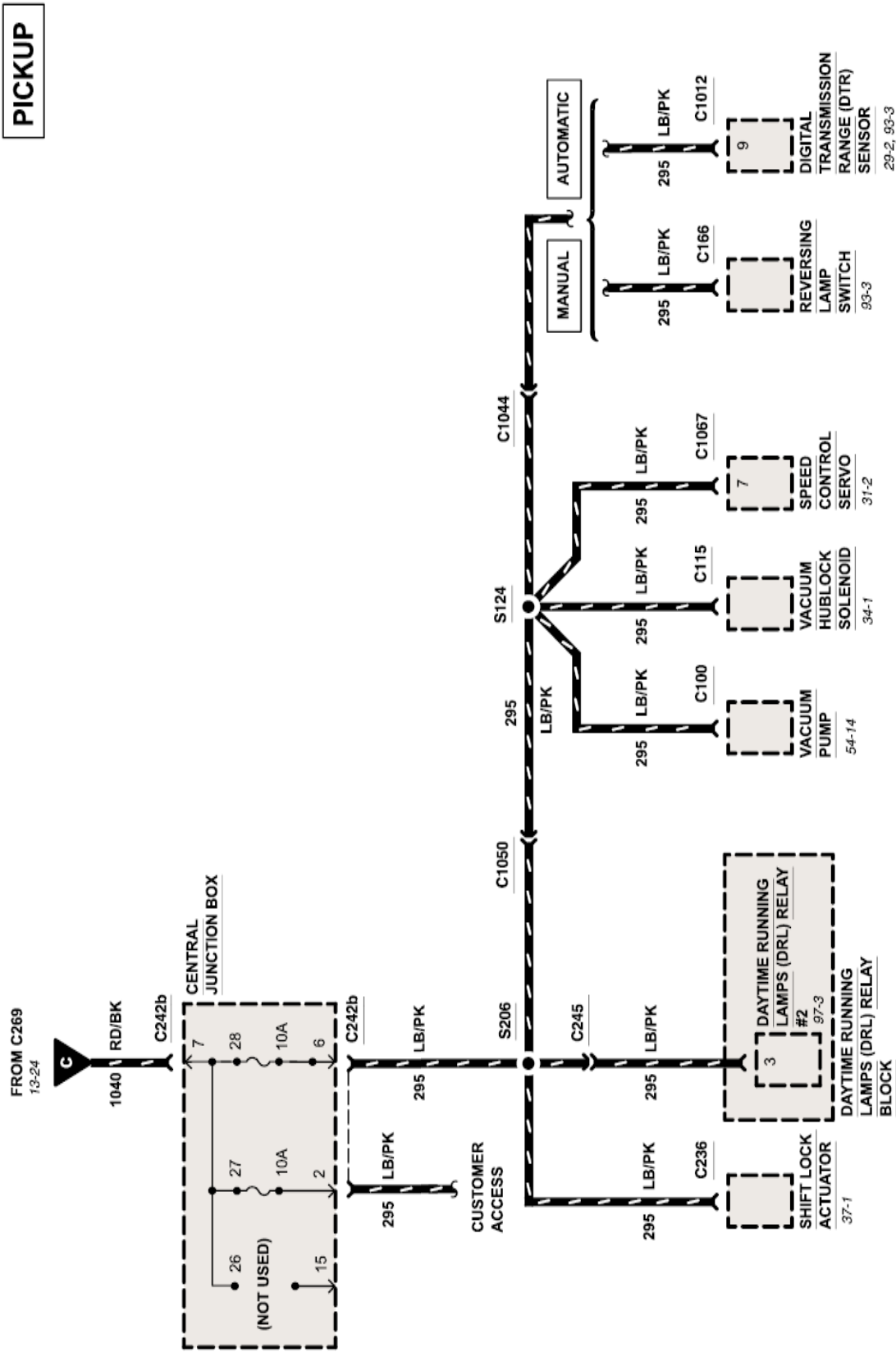

# POWER DISTRIBUTION 13-34

2000 EXCURSION, SUPER DUTY SERIES F-250, F-350, F-450, F-550

PICKUP

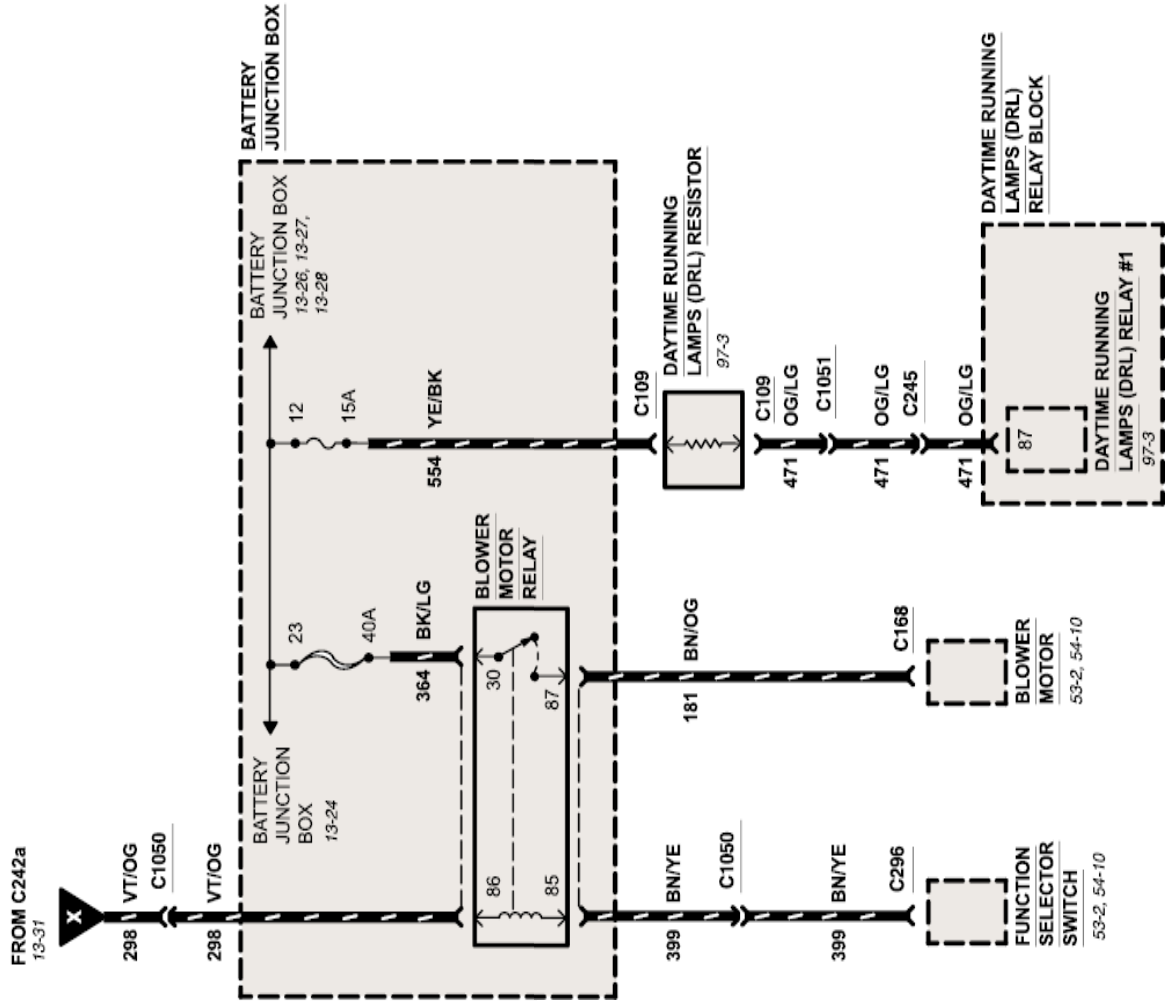

# 13-35 POWER DISTRIBUTION

2000 EXCURSION, SUPER DUTY SERIES F-250, F-350, F-450, F-550

